

*Connect With Quality . . .*



WWW.NBGNL.COM

## **ELEVATOR UNIVERSAL**

**S P A R E P A R T S**

**ISO 9001:2015 CERTIFIED COMPANY**

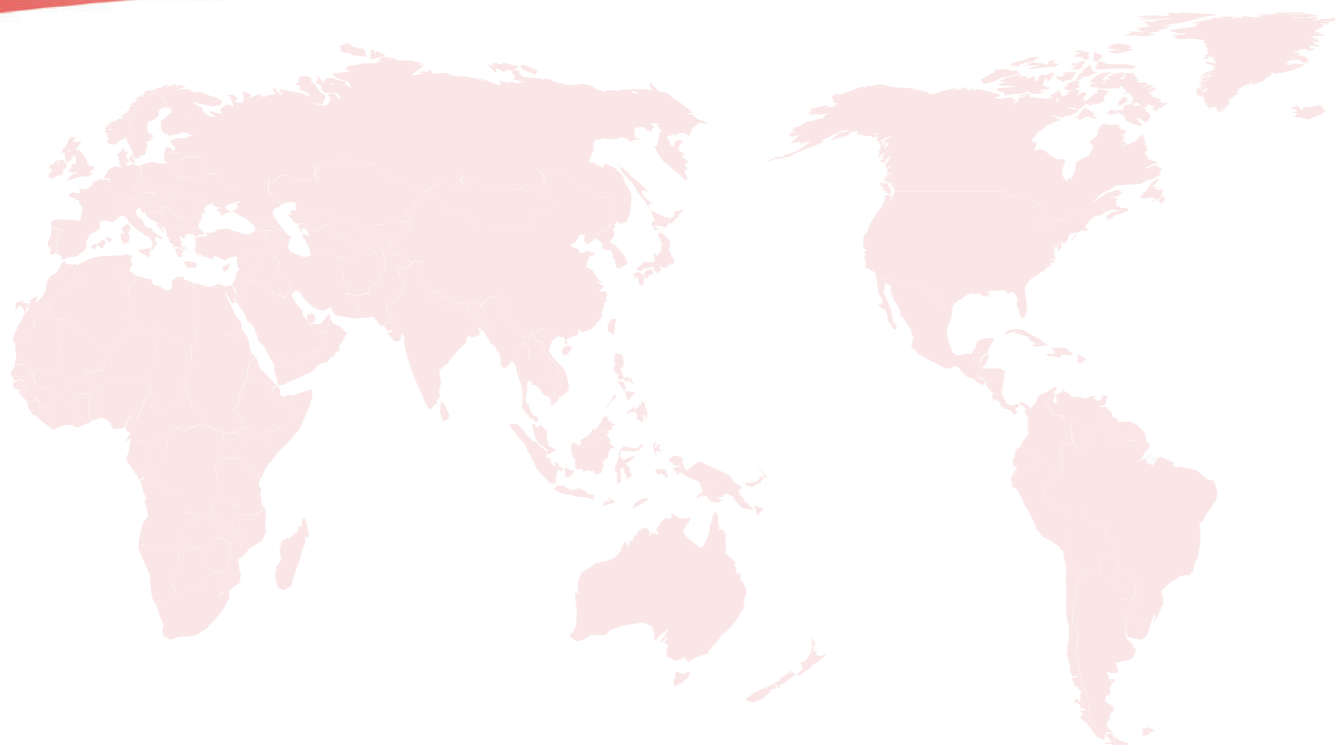

### **NINGBO GNL ELEVATOR SPARE PARTS CO., LTD.**

**宁波歌诺电梯配件有限公司**

OFFICE ADDRESS: SOUTHERN STREET (SBD), YINZHOU, NINGBO CITY, CHINA.

FACTORY ADDRESS: DAQI STREET, BEILUN, NINGBO CITY, CHINA.

MAIL: INFO@NBGNL.COM

PHONE: +86-057455681351

WEB: WWW.NBGNL.COM

地址: 中国宁波鄞州区南部商务区

工厂地址: 中国宁波北仑区大碶街道

邮箱: INFO@NBGNL.COM

手机: +86-057455681351

网站: WWW.NBGNL.COM

### **NINGBO GNL ELEVATOR SPARE PARTS CO., LTD.**

**宁波歌诺电梯配件有限公司**

The printed products are for reference only the company has the right change the designs and specifications of the products at any time. Information contained in the printed does products does not constitute any express or implied guarantees or commitment for the products and its applicability, merchantability, and quality of special purposes, or any terms of procurement agreement.

2024 © Copyright | Ningbo GNL Elevator Spare Parts Co., Ltd. | All Rights Reserved



## HONORS 荣誉



65+

COUNTRY EXPORT

出口国家

50+

EMPLOYEES

员工人数

10+

PATENTS

专利数量

## COMPANY PROFILE 公司简介

Welcome to **Ningbo GNL Elevator Spare Parts Co., Ltd.**, a leading provider of high-quality elevator spare parts and components for the global elevator industry. Our mission is to provide our customers with the highest level of service, quality, and reliability in the elevator spare parts industry.

With over two decades of experience, we have established ourselves as a trusted partner for elevator maintenance and repair professionals around the world. Our team of experts is dedicated to providing the latest and most innovative products, as well as expert technical support and customer service.

At Elevator Spare Parts Exporting Company, we understand the importance of safety and reliability in the elevator industry. That's why we only manufacturer GNL Brand product with highest standard & Quality and beside we source our products & raw material from reputable and reliable manufacturers, and why we offer a wide range of elevator components, including, Elevator Light Curtain, COP, LOP, Display, Fan, Limit Switch, Intercom System, Cable Sets, Traction Machines, Control Systems, Guide Rail and much more. We also offer customized solutions to meet the specific needs of our customers.

We take pride in our commitment to quality and customer satisfaction. Our state-of-the-art facilities and experienced team ensure that all of our products meet the highest standards of quality and performance. Additionally, our team is available 24/7 to provide technical support and assist with any questions or concerns.

We are dedicated to providing our customers with a seamless and efficient shopping experience. Our user-friendly website makes it easy to find the products you need.

Thank you for considering Ningbo GNL Company for all of your elevator spare parts and components needs. We look forward to working with you and helping you keep your elevators running smoothly and safely. If you have any questions, please don't hesitate to contact us.





# OUR JOURNEY



# CONTENT

- 01 ELEVATOR COP LOP / 电梯操纵盘外呼
- 15 ELEVATOR LIGHT CURTAIN / 电梯光幕
- 19 ELEVATOR INTERCOM SET / 电梯对讲
- 20 ELEVATOR SWITCH & ENCODER / 电梯开关和编码器
- 21 ELEVATOR CABIN FLOW FAN / 电梯轿厢风机
- 23 ELEVATOR DOOR OPERATER & HEADER / 电梯开门机 & 层门装置
- 29 ELEVATOR TRACTION MACHINE / 电梯曳引机
- 31 ELEVATOR ROPE & CABLE & PULLEY / 电梯钢丝绳 & 电缆 & 尼龙轮
- 32 ELEVATOR ROPE FASTENING / 电梯绳头组合
- 33 ELEVATOR BUFFER / 电梯缓冲器
- 34 ELEVATOR OVER SPEED GOVERNOR / 电梯限速器
- 35 ELEVATOR SAFETY GEAR SET / 电梯安全钳
- 36 ELEVATOR OIL BOX & SWITCH & POWER BOX / 电梯油杯 & 开关 & 电源盒
- 37 ELEVATOR GUIDE RAIL / 电梯导轨
- 38 ELEVATOR GUIDE SHOE / 电梯导靴
- 39 ELEVATOR CONTROL SYSTEM / 电梯控制系统
- 42 ELEVATOR MODERNIZATION / 电梯现代化改造
- 43 ELEVATOR LOCK & KEY / 电梯锁 & 钥匙
- 45 ELEVATOR AVR & ARD / 电梯 AVR & ARD
- 46 ELEVATOR CABIN & DOOR / 电梯轿厢和门

ELEVATOR BOX TYPE COP 电梯底盒式操纵盘

ELEVATOR WALLMOUNTED TYPE COP 电梯壁挂式操纵盘



GNLCOPBX-1 GNLCOPBX-2 GNLCOPBX-3 GNLCOPBX-4 GNLCOPBX-5 GNLCOPBX-6 GNLCOPBX-7



GNLCOPWM-1 GNLCOPWM-2 GNLCOPWM-3 GNLCOPWM-4 GNLCOPWM-5 GNLCOPWM-6 GNLCOPWM-7



GNLCOPBX-8 GNLCOPBX-9 GNLCOPBX-10 GNLCOPBX-11 GNLCOPBX-12 GNLCOPBX-13 GNLCOPBX-14



GNLCOPWM-8 GNLCOPWM-9 GNLCOPWM-10 GNLCOPWM-11 GNLCOPWM-12 GNLCOPWM-13 GNLCOPWM-14

ELEVATOR WALLMOUNTED TYPE COP 电梯壁挂式操纵盘

ELEVATOR FULL HEIGHT TYPE COP 电梯一体式操纵盘

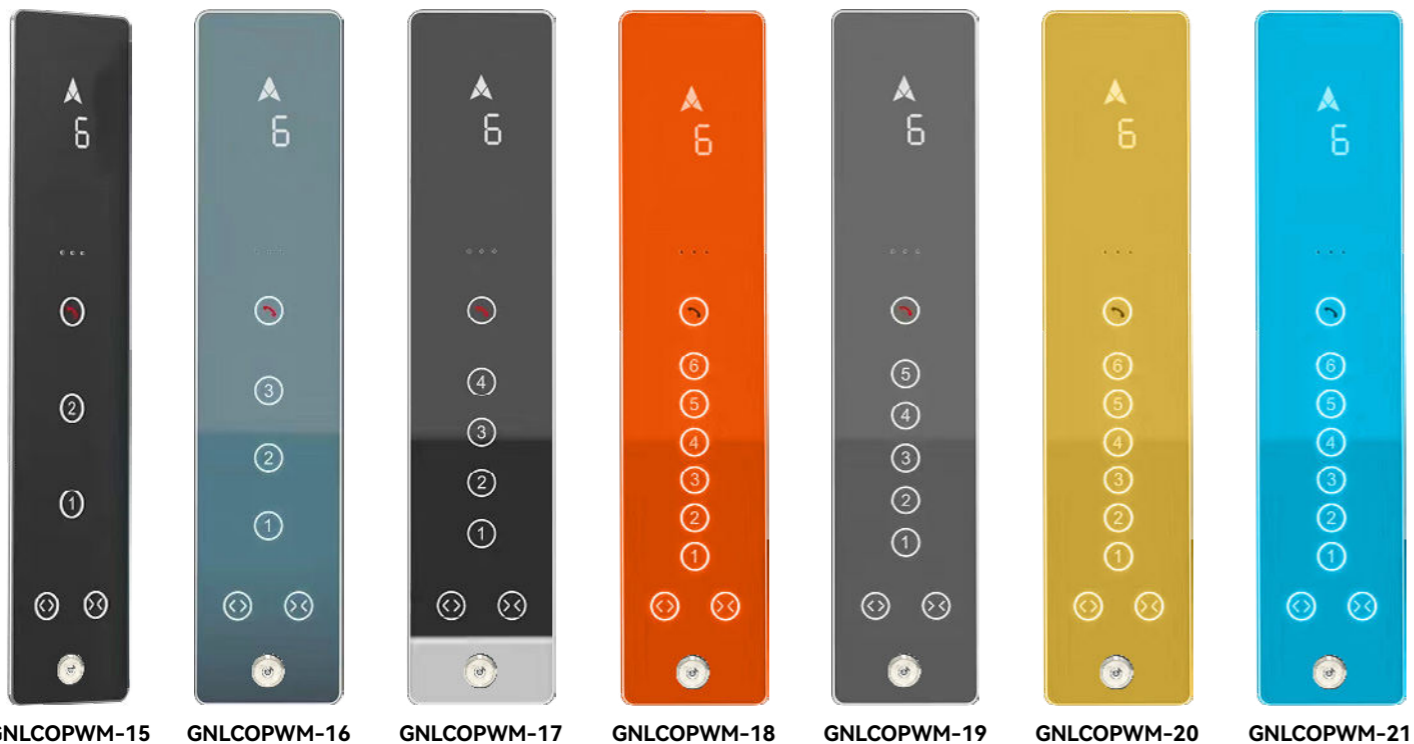

### ELEVATOR WHEELCHAIR TYPE COP 电梯无障碍操纵盘



GNLWCOP-1



GNLWCOP-2

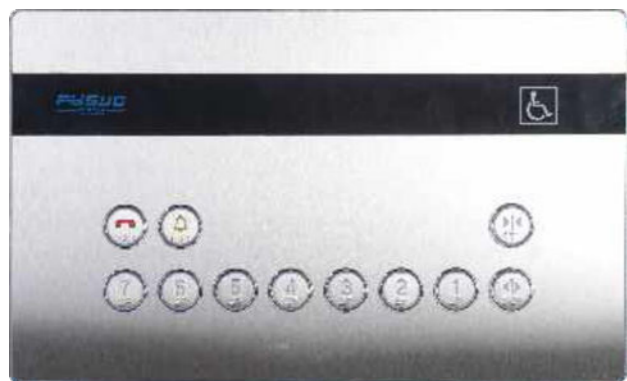

GNLWCOP-3



GNLWCOP-4



GNLWCOP-5

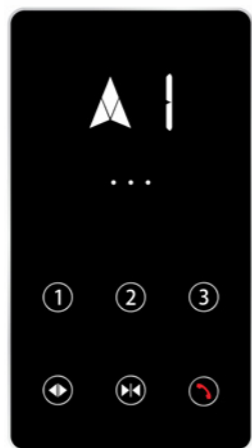

GNLWCOP-8

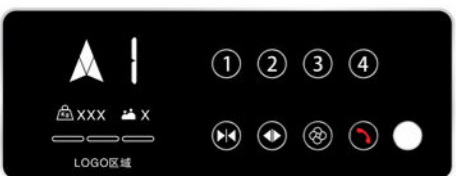

GNLWCOP-6

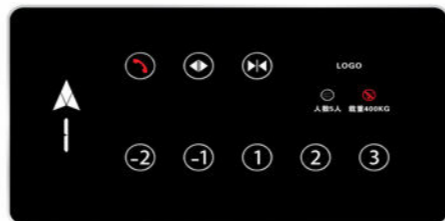

GNLWCOP-9



GNLWCOP-7



GNLWCOP-10

### HOME LIFT LOP 家用梯外呼

GNLLOPHL-1

GNLLOPHL-2

GNLLOPHL-3

### ELEVATOR LOP 电梯外呼



GNLLOPWM-1



GNLLOPWM-2



GNLLOPWM-3



GNLLOPWM-4



GNLLOPWM-5



GNLLOPWM-6



GNLLOPWM-7



GNLLOPWM-8



GNLLOPWM-9



GNLLOPWM-10



GNLLOPWM-11



GNLLOPWM-12



GNLLOPWM-13



GNLLOPWM-14



GNLLOPWM-15



GNLLOPWM-16



GNLLOPWM-17

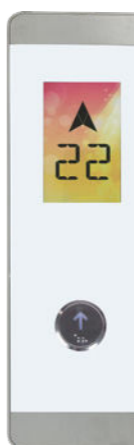

GNLLOPWM-18



GNLLOPWM-19



GNLLOPWM-20



GNLLOPWM-21

ELEVATOR LOP 电梯外呼

ELEVATOR LOP 电梯外呼

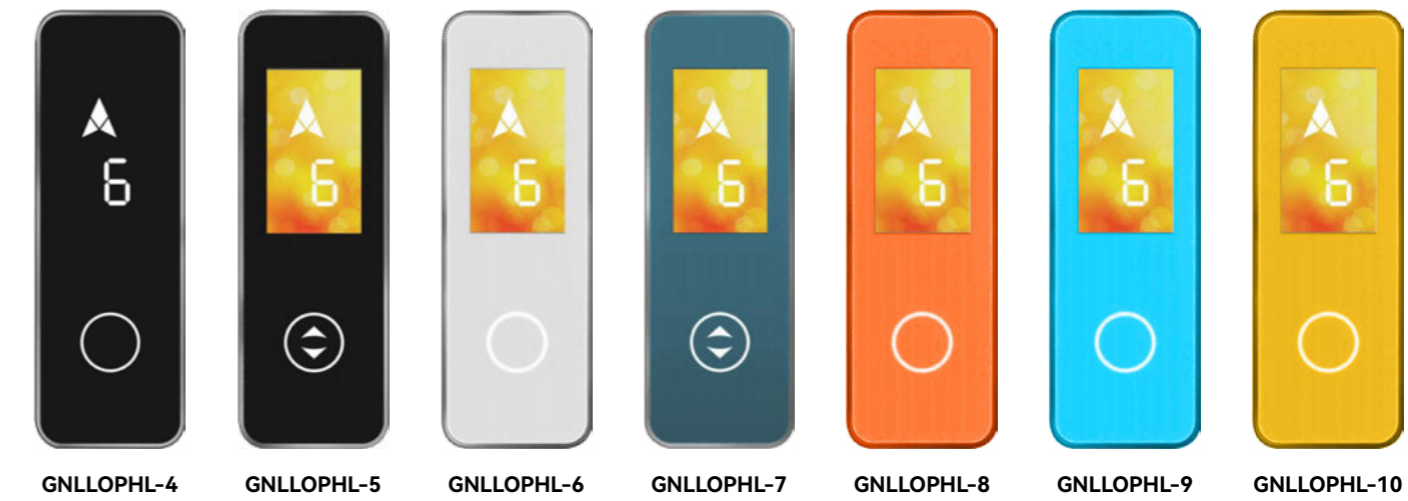

◆ SERIAL/PARALLEL/ BCD/ 7SEGMENT/CAN/RSL/RS485

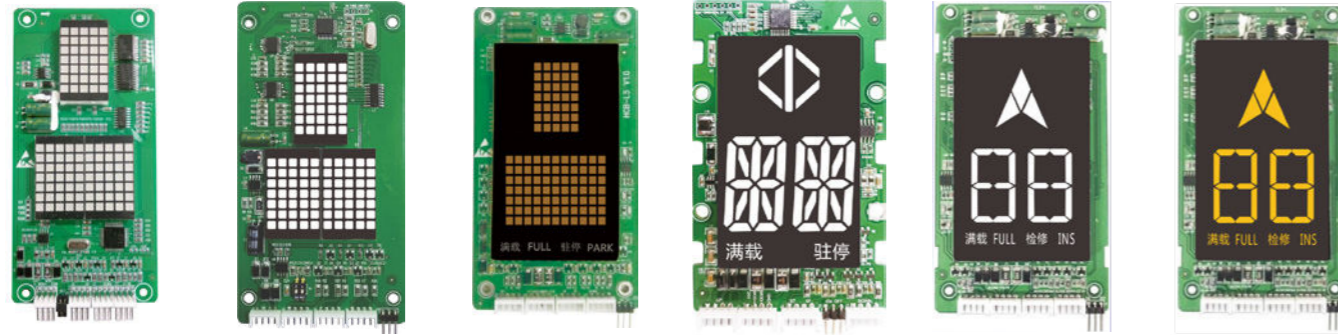

**GNL-DOT-R**  
• 4.3 INCH DOT DISPLAY  
• INSTALL SIZE:134\*56MM - 安装尺寸  
• FACEPLATE:94\*46MM - 面板尺寸

**GNL-DOT-R-BO**  
• 4.3 INCH DOT DISPLAY  
• INSTALL SIZE:94\*52MM - 安装尺寸  
• FACEPLATE:118\*60MM - 面板尺寸

**GNL-DOT-NBO**  
• 4.3 INCH DOT DISPLAY  
• INSTALL SIZE:134\*56MM - 安装尺寸  
• FACEPLATE:94\*46MM - 面板尺寸

**GNL-LED-R**  
• 4.3 INCH LED DISPLAY  
• INSTALL SIZE:58\*40MM - 安装尺寸  
• FACEPLATE:76\*46MM - 面板尺寸

**GNL-LED-R-NW-WH**  
• 4.3 INCH LED DISPLAY  
• INSTALL SIZE:118\*60MM - 安装尺寸  
• FACEPLATE:92\*55MM - 面板尺寸

**GNL-LED-R-NW-ORG**  
• 4.3 INCH LED DISPLAY  
• INSTALL SIZE:118\*60MM - 安装尺寸  
• FACEPLATE:92\*55MM - 面板尺寸

◆ SERIAL/PARALLEL/ BCD/ 7SEGMENT/CAN/RSL/RS485



**GNL-LCD-BO-BL**  
• 4.3 INCH LCD DISPLAY  
• INSTALL SIZE:118\*60MM - 安装尺寸  
• FACEPLATE:92\*55MM - 面板尺寸

**GNL-LCD-BO-BU**  
• 4.3 INCH LCD DISPLAY  
• INSTALL SIZE:118\*61MM - 安装尺寸  
• FACEPLATE:92\*56MM - 面板尺寸

**GNL-CBLCD-BO-LIGH**  
• 4.3 INCH LCD DISPLAY  
• INSTALL SIZE:118\*61MM - 安装尺寸  
• FACEPLATE:92\*57MM - 面板尺寸

**GNL-CBLCD-BO-LEAF**  
• 4.3 INCH LCD DISPLAY  
• INSTALL SIZE:118\*63MM - 安装尺寸  
• FACEPLATE:92\*58MM - 面板尺寸

**GNL-HD-R-BO-WTR**  
• 4.3 INCH HD DISPLAY  
• INSTALL SIZE:118\*61MM - 安装尺寸  
• FACEPLATE:92\*56MM - 面板尺寸

**GNL-HD-R-BO-BLU**  
• 4.3 INCH TFT DISPLAY  
• INSTALL SIZE:118\*62MM - 安装尺寸  
• FACEPLATE:92\*57MM - 面板尺寸

◆ SERIAL/PARALLEL/ BCD/ 7SEGMENT/CAN/RSL/RS485

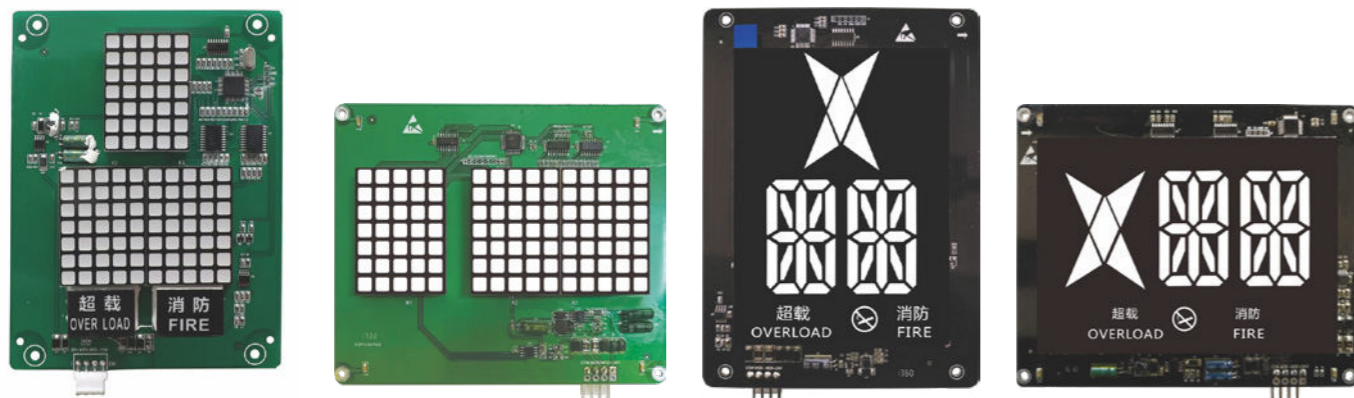

**GNL-DOT-64**  
• 6.4 INCH DOT DISPLAY  
• INSTALL SIZE:160\*105MM- 安装尺寸  
• FACEPLATE:140\*80MM - 面板尺寸

**GNL-DOT-64-HZ**  
• 6.4 INCH DOT DISPLAY  
• INSTALL SIZE:129\*147MM- 安装尺寸  
• FACEPLATE:94\*129MM - 面板尺寸

**GNL-LED-64**  
• 6.4 INCH DOT DISPLAY  
• INSTALL SIZE:160\*106MM- 安装尺寸  
• FACEPLATE:130\*95MM - 面板尺寸

**GNL-LED-64-HZ**  
• 6.4 INCH DOT DISPLAY  
• INSTALL SIZE:94\*130MM - 安装尺寸  
• FACEPLATE:95\*130MM - 面板尺寸

◆ SERIAL/PARALLEL/ BCD/ 7SEGMENT/CAN/RSL/RS485

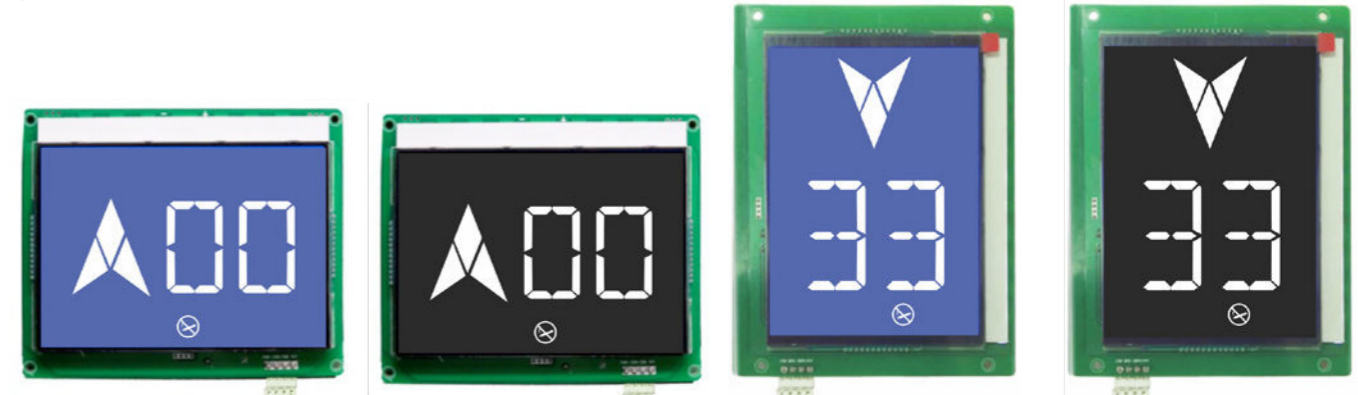

**GNL-LCD-64-HZ**  
• 6.4 INCH LCD DISPLAY  
• INSTALL SIZE:94\*130MM - 安装尺寸  
• FACEPLATE:95\*130MM - 面板尺寸

**GNL-LCD-64-HZ**  
• 6.4 INCH LCD DISPLAY  
• INSTALL SIZE:94\*130MM - 安装尺寸  
• FACEPLATE:95\*130MM - 面板尺寸

**GNL-LCD-64**  
• 6.4 INCH LCD DISPLAY  
• INSTALL SIZE:160\*106MM- 安装尺寸  
• FACEPLATE:130\*95MM - 面板尺寸

**GNL-LCD-64**  
• 6.4 INCH LCD DISPLAY  
• INSTALL SIZE:160\*106MM- 安装尺寸  
• FACEPLATE:130\*95MM - 面板尺寸

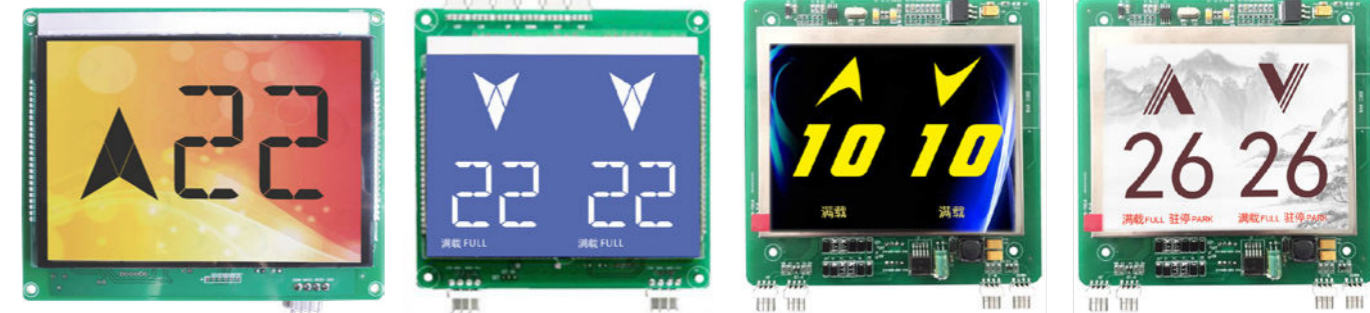

**GNL-CBLCD-64-HZ**  
• 6.4 INCH LCD DISPLAY  
• INSTALL SIZE:94\*131MM - 安装尺寸  
• FACEPLATE:95\*131MM - 面板尺寸

**GNL-LCD-64-DPLX**  
• 6.4 INCH LCD DISPLAY  
• INSTALL SIZE:115\*120MM- 安装尺寸  
• FACEPLATE:86\*115MM - 面板尺寸

**GNL-HD-56-DPLX-BLU**  
• 5.6 INCH HD DUPLEX DISPLAY  
• INSTALL SIZE:115\*120MM- 安装尺寸  
• FACEPLATE:87\*115MM - 面板尺寸

**GNL-HD-56-DPLX-WIT**  
• 5.6 INCH HD DUPLEX DISPLAY  
• INSTALL SIZE:115\*120MM- 安装尺寸  
• FACEPLATE:87\*115MM - 面板尺寸



**GNL-TFT-7**  
• 7 INCH TFT DISPLAY  
• INSTALL SIZE:80\*180MM - 安装尺寸  
• FACEPLATE:85\*152MM - 面板尺寸



**GNL-TFT-8**  
• 8 INCH TFT DISPLAY  
• INSTALL SIZE:116\*198MM- 安装尺寸  
• FACEPLATE:121\*161MM - 面板尺寸



**GNL-TFT-10**  
• 10 INCH TFT DISPLAY  
• INSTALL SIZE:156\*209MM- 安装尺寸  
• FACEPLATE:87\*118MM - 面板尺寸



◆ SERIAL/PARALLEL/BCD/7SEGMENT/CAN/RSL/RS485



**GNL-TFT-12**  
 • 12 INCH TFT DISPLAY  
 • INSTALL SIZE:149\*292MM- 安装尺寸  
 • FACEPLATE:180\*242MM - 面板尺寸



**GNL-TFT-15**  
 • 15 INCH TFT DISPLAY  
 • INSTALL SIZE:220\*275MM- 安装尺寸  
 • FACEPLATE:306\*232MM - 面板尺寸



**GNL-TFT-18**  
 • 18 INCH TFT DISPLAY  
 • INSTALL SIZE:300\*360MM- 安装尺寸  
 • FACEPLATE:232\*412MM - 面板尺寸

**HALL LANTERN 到站灯**

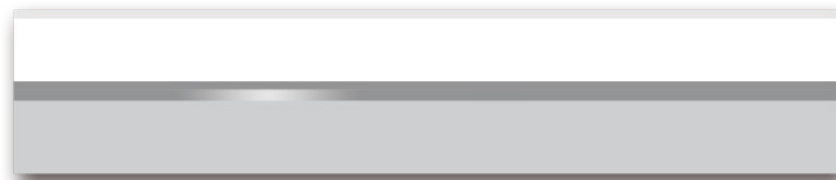

• GNL-HALL-1

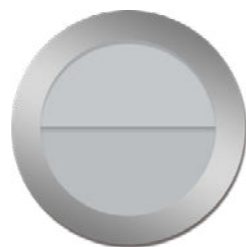

• GNL-HALL-2



**LANDING OVERHEAD PANEL 门头横显**



• GNL-HALLM-1



• GNL-HALLM-2



• GNL-HALLM-3



• GNL-HALLM-4



• GNL-HALLM-5

**FIREMAN SWITCH 消防开关**



ELEVATOR TOUCH COP 电梯触摸操作盘

**GNLTCOP-1**  
• Size 尺寸: 4 inch

**GNLTCOP-2**  
• Size 尺寸: 10.4 inch

**GNLTCOP-3**  
• Size 尺寸: 10.1 inch

**GNLTCOP-4**  
• Size 尺寸: 10.1 inch

**GNLTCOP-5**  
• Size 尺寸: 4.3 inch

**GNLTCOP-6**  
• Size 尺寸: 13.3 inch

**GNLTCOP-7**  
• Size 尺寸: 13.3 inch

**GNLTCOP-8**  
• Size 尺寸: 13.3 inch

**GNLTCOP-9**  
• Size 尺寸: 15.6 inch

**GNLTCOP-10**  
• Size 尺寸: 15.6 inch

**GNLTCOP-11**  
• Size 尺寸: 21.5 inch

**GNLTCOP-12**  
• Size 尺寸: 21.5 inch

**GNLTCOP-13**  
• Size 尺寸: 29 inch

ELEVATOR PUSH BUTTON 电梯按钮

GNLEPB-1	GNLEPB-2	GNLEPB-3	GNLEPB-4	GNLEPB-5
GNLEPB-6	GNLEPB-7	GNLEPB-8	GNLEPB-9	GNLEPB-10
GNLEPB-11	GNLEPB-12	GNLEPB-13	GNLEPB-14	GNLEPB-15
GNLEPB-16	GNLEPB-17	GNLEPB-18	GNLEPB-19	GNLEPB-20
GNLEPB-21	GNLEPB-22	GNLEPB-23	GNLEPB-24	GNLEPB-25
GNLEPB-26	GNLEPB-27	GNLEPB-28	GNLEPB-29	GNLEPB-30
GNLEPB-31	GNLEPB-32	GNLEPB-33	GNLEPB-34	GNLEPB-35
GNLEPB-36	GNLEPB-37	GNLEPB-38	GNLEPB-39	GNLEPB-40
GNLEPB-41	GNLEPB-42	GNLEPB-43	GNLEPB-44	PUSH BUTTON SIGN 字片



GNL-B96/B154/B174/B194-A (UNIVERSAL, CENTER AND SIDE/ 中分通用款)

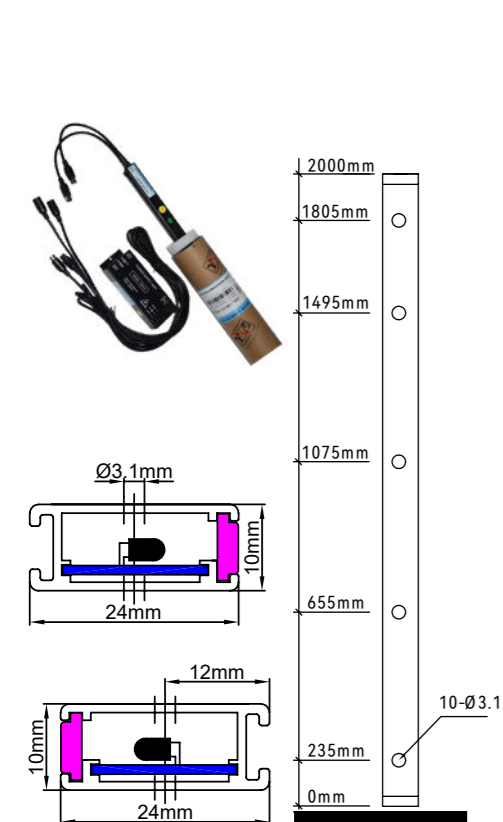

GNL-B96/B154/B174/B194-A TECHNICAL SPECIFICATIONS/ 技术规格 table with columns for Model, Number of diodes, Distance between diodes, etc.

GNL-3D (CENTER OPEN SPECIAL/ 中分特殊款)

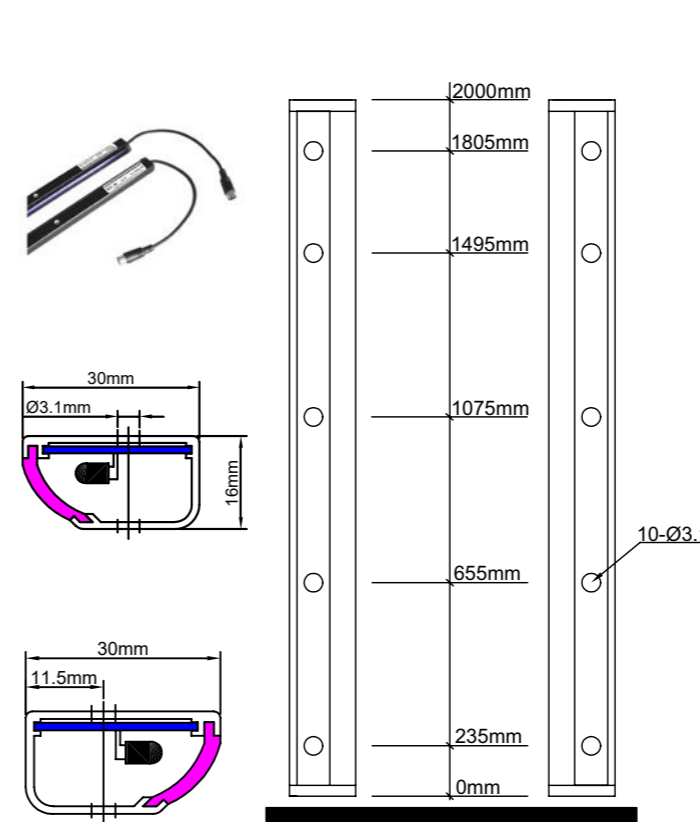

GNL-3D Specification of light curtain / 光幕规格 table with columns for Model, Number of diodes, Distance between diodes, etc.

GNL-B96/B154/B174/B194-T (SIDE OPEN SPECIAL/ 旁开特殊款)

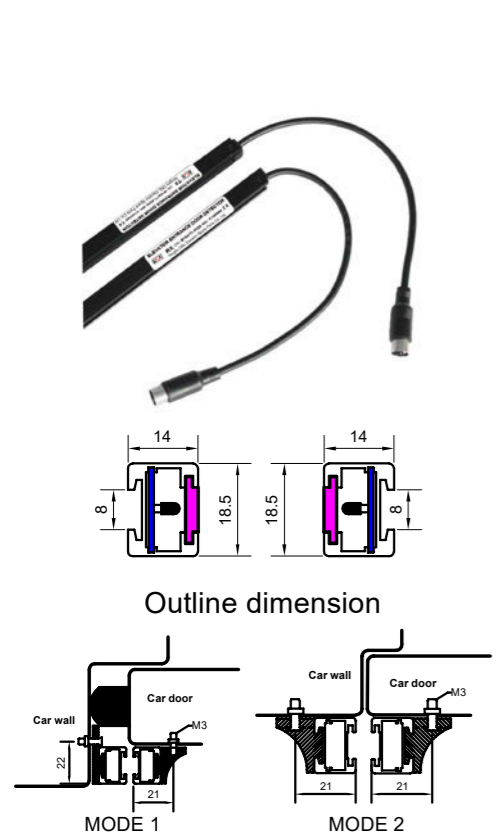

GNL-B96/B154/B174/B194-T TECHNICAL SPECIFICATIONS/ 技术规格 table with columns for Model, Number of diodes, Distance between diodes, etc.

GNL-B96/B154/B174/B194-D (HOME LIFT/ 家用梯款)

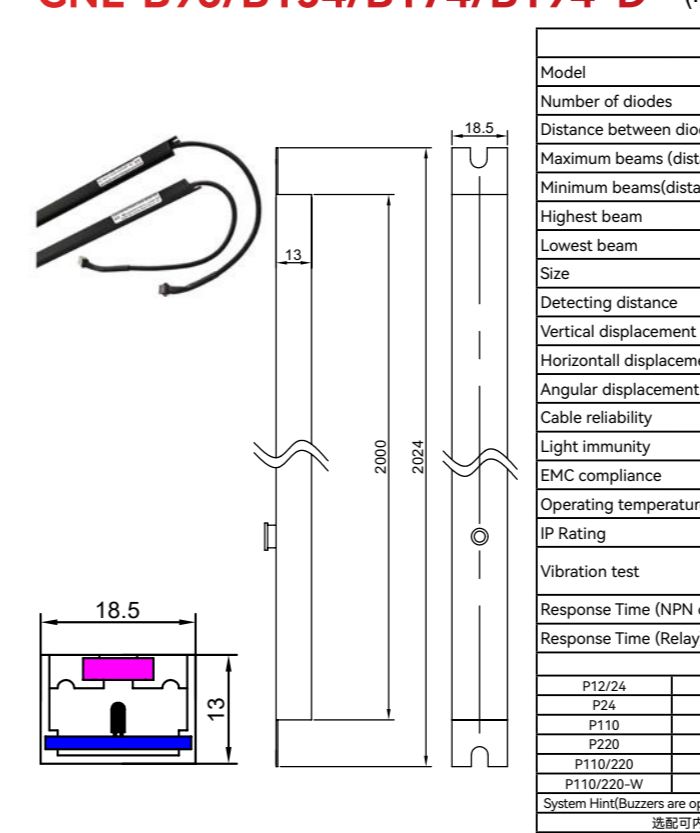

GNL-B96/B154/B174/B194-D TECHNICAL SPECIFICATIONS/ 技术规格 table with columns for Model, Number of diodes, Distance between diodes, etc.



## GNL-B96/B154/B174/B194-C (TWO IN ONE/ 二合一款)

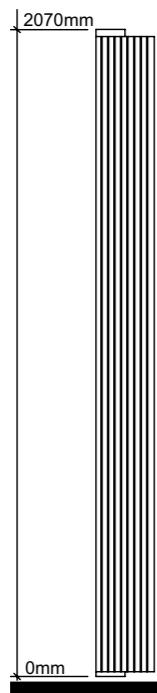
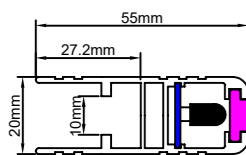
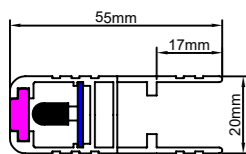

GNL-B96/B154/B174/B194-C TECHNICAL SPECIFICATIONS/ 技术规格					
Model	型号	GNL-B96-C	GNL-B154-C	GNL-B174-C	GNL-B194-C
Number of diodes	发射管数	17	32	36	40
Distance between diodes	光电器件的中心距离	115.8mm	57.9mm	45.7mm	45.7mm
Maximum beams (distance ≥ 400mm)	最大光束 (距离 ≥ 400mm)	96 beams	154 beams	174 beams	194 beams
Minimum beams (distance < 400mm)	最小光束 (距离 < 400mm)	33 beams	94 beams	106 beams	118 beams
Highest beam	最高光束	≥ 1800mm			
Lowest beam	最低光束	≤ 20mm			
Size	光幕外形尺寸	20mm X 55mm X 2070mm			
Detecting distance	开门测量距离	0~4000mm			
Vertical displacement at 0mm	垂直安装允差在 0mm 处	±40mm			
Horizontal displacement at 0mm	水平安装允差在 0mm 处	±5mm			
Angular displacement at 0mm	角度安装允差在 0mm 处	±10°			
Cable reliability	电线可靠性	20 million door movements			
Light immunity	抗光干扰度	Not less than 100,000LUX			
EMC compliance	电磁兼容标准	Emissions to EN12015, Immunity to EN12016			
Operating temperature range	工作温度范围	-20°C ~ +65°C			
IP Rating	IP 等级	IP65			
Vibration test	振动试验	Random vibration 20 to 500Hz 4hrs per axis Sinusoidal vibration 30Hz 30mins per axis			
Response Time (NPN or PNP)	响应时间 (NPN 或 PNP)	45ms	65ms	55ms	65ms
Response Time (Relay)	响应时间 (继电器)	60ms	80ms	80ms	90ms
POWER SUPPLY UNIT/ 电源单元					
P12/24	Input voltage 10-35VDC 4VA	输入电压 10-35V DC 4VA			
P24	Input voltage 19-35VDC 4VA or 18-30V AC 4VA	输入电压 19-35V 直流 4VA 或 18-30V 交流 4VA			
P110	Input voltage 85-135V AC 4VA	输入电压 85-135V AC 4VA			
P220	Input voltage 175-300V AC 4VA	输入电压 175-300V AC 4VA			
P110/220	Input voltage 110V/220V AC (Switchable) 4VA	输入电压 110V/220V AC (可切换) 4VA			
P110/220-W	Input voltage 85-285V AC 4VA	输入电压 85-285V AC 4VA			
System Hint (Buzzers are optional) Mode 1: Give buzzer sound once interrupted. Mode 2: Give buzzer sound 15 seconds after continuously interrupted. 选配可内置蜂鸣器声音报警, 两种模式可选择: 1、光幕只要有阻挡就报警 2、光幕连续阻挡 15 秒后开始报警					

## GNL-BSV-3D (Binocular Stereo Vision/ 视觉光幕 / 双目立体视觉)

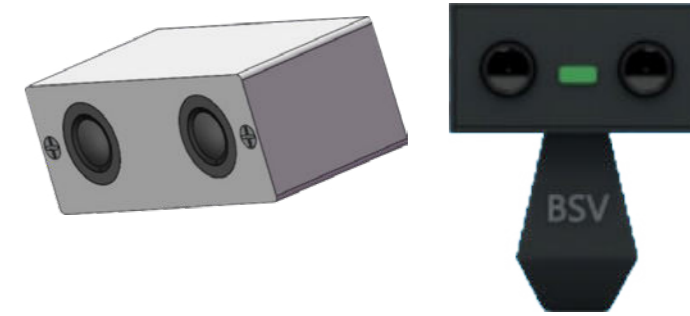
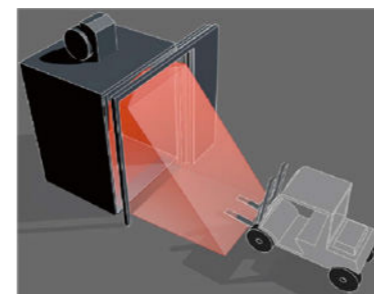
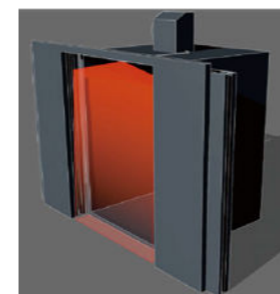
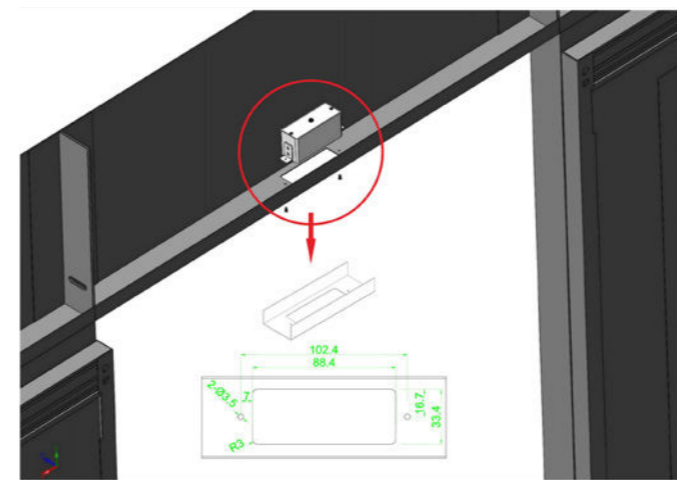

GNL-BSV(Binocular Stereo Vision/ 视觉光幕 / 双目立体视觉)		
Input voltage 输入电压 USP	10~35VDC 4W	
Transistor output 晶体管输出	Mode 1	PNP/NPN(Push-Pull)
Output logic 输出逻辑		NO/NC Optional
Relay output 继电器输出	Mode 2	COM/NC COM/NO
Response time 响应时间	100ms	
Outline dimensions (Width*Height*Length) 外形尺寸 (宽*高*长)	33×40×88 mm	
Case material 外壳材质	Aluminium alloy 铝合金	
IP protection rate / IP 保护等级	IP65	
Temperature 温度	-20°C ~ +65°C	
Electromagnetic compatibility standard 电磁兼容标准	Radiation compliance :EN12015 Anti-interference compliance :EN12016 辐射符合 :EN12015, 抗干扰符合 :EN12016	
Vibration test 振动试验	Random vibration 4 hours per axis, frequency 20 to 500 HZ. Sinusoidal vibration 30 minutes, frequency 30 HZ. 每轴随机振动 4 小时, 振动频率为 20-500HZ. 正弦波振动 30 分钟, 振动频率为 30HZ	

## GNL-B96/B154/B174/B194-H (EXTRA PROTECTION/ 额外保护款)

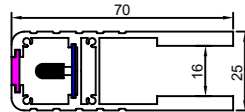
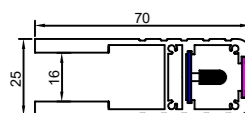

GNL-B96/B154/B174/B194-H TECHNICAL SPECIFICATIONS/ 技术规格					
Model	型号	GNL-B96-H	GNL-B154-H	GNL-B174-H	GNL-B194-H
Number of diodes	发射管数	17	32	36	40
Distance between diodes	光电器件的中心距离	115.8mm	57.9mm	45.7mm	45.7mm
Maximum beams (distance ≥ 400mm)	最大光束 (距离 ≥ 400mm)	96 beams	154 beams	174 beams	194 beams
Minimum beams (distance < 400mm)	最小光束 (距离 < 400mm)	33 beams	94 beams	106 beams	118 beams
Highest beam	最高光束	≥ 1800mm			
Lowest beam	最低光束	≤ 20mm			
Size	光幕外形尺寸	25mm X 70mm X 2100mm			
Detecting distance	开门测量距离	0~4000mm			
Vertical displacement at 0mm	垂直安装允差在 0mm 处	±30mm			
Horizontal displacement at 0mm	水平安装允差在 0mm 处	±5mm			
Angular displacement at 0mm	角度安装允差在 0mm 处	±10°			
Cable reliability	电线可靠性	20 million door movements			
Light immunity	抗光干扰度	Not less than 100,000LUX			
EMC compliance	电磁兼容标准	Emissions to EN12015, Immunity to EN12016			
Operating temperature range	工作温度范围	-20°C ~ +65°C			
IP Rating	IP 等级	IP65			
Vibration test	振动试验	Random vibration 20 to 500Hz 4hrs per axis Sinusoidal vibration 30Hz 30mins per axis			
Response Time (NPN or PNP)	响应时间 (NPN 或 PNP)	45ms	65ms	55ms	65ms
Response Time (Relay)	响应时间 (继电器)	60ms	80ms	80ms	90ms
POWER SUPPLY UNIT/ 电源单元					
P12/24	Input voltage 10-35V DC 4VA	输入电压 10-35V DC 4VA			
P24	Input voltage 19-35V DC 4VA or 18-30V AC 4VA	输入电压 19-35V 直流 4VA 或 18-30V 交流 4VA			
P110	Input voltage 85-135V AC 4VA	输入电压 85-135V AC 4VA			
P220	Input voltage 175-300V AC 4VA	输入电压 175-300V AC 4VA			
P110/220	Input voltage 110V/220V AC (Switchable) 4VA	输入电压 110V/220V AC (可开关) 4VA			
P110/220-W	Input voltage 85-285V AC 4VA	输入电压 85-285V AC 4VA			
System Hint (Buzzers are optional) Mode 1: Give buzzer sound once interrupted. Mode 2: Give buzzer sound 15 seconds after continuously interrupted. 选配可内置蜂鸣器声音报警, 两种模式可选择: 1、光幕只要有阻挡就报警 2、光幕连续阻挡 15 秒后开始报警					

## Power Box 电源盒

Model 型号	Voltage Input 输入电压	Power box outline dimensions 电源盒外形尺寸	Indicator light status 指示灯状态
GNL-P110	110V±20%	153mm(L)X67mm(W) X39.5mm(H)	Signal Indicator 信号指示灯 Power Indicator 电源指示灯 
GNL-P220	175-300V AC		
GNL-P12/24	10-35V DC		
GNL-P24	19-35V DC/18-30V AC		
GNL-P24-EU	10-35V DC	178mm(L)X67mm(W) X39.5mm(H)	
GNL-P110/220-W	85-265V AC		
GNL-P220-S	185-300V AC		
GNL-P220-EU	185-300V AC	200.5mm(L)X67mm(W) X39.5mm(H)	
GNL-P110/220-3D	85-265V AC		
Green light: Continuous ON with normal power supply / Red light: ON if normal scanning, OFF if beams interrupted 绿灯电源正常时常亮光幕正常时灭, 阻挡时亮红灯			



Power Box GNL-P220



Power Box GNL-P220-EU

## Door Safety Edges 安全触板



## Power Cable 电缆

Model	Length
GNL-LCPBC-3M	3 Meters Cable
GNL-LCPBC-5M	5 Meters Cable
GNL-LCPBC-7M	7 Meters Cable
GNL-LCPBC-10M	10 Meters Cable

**GNL-INCTM-3WY**

- ELEVATOR THREE WAY INTERCOM SET
- 电梯三方对讲

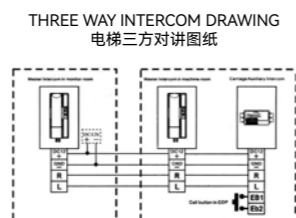
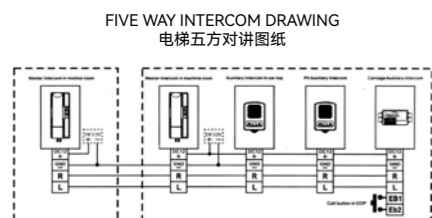

**GNL-INCTM-5WY**

- ELEVATOR FIVE WAY INTERCOM SET
- 电梯五方对讲



**GNL-LS-1370**

- ELEVATOR LIMIT SWITCH 电梯限位开关

**OPTIONAL 选项**





100% 纯铜电机  
性能优良

100% PURE COPPER MOTOR WITH  
STRONG POWER



风扇叶轮  
高风量  
均匀风速

IMPELLER  
HIGH AIR VOLUME  
UNIFORM INLET AND OUTLET AIR



配备双轴承  
低音耐用

DOUBLE BEARING MAKES  
LOW NOISE WITH LONG LIFE



GNL CODE GNL 编码	ROTATE SPEED 转速	AIR VOLUME 风量	POWER 功率	OUTLET SIZE 外尺寸	INSTALL SIZE 安装尺寸
	RPM	M/MIN	W	MM	MM
GNL-FB9B(220V)-01	1250	5.5	25	273X43	380X90
GNL-FB9B(220V)-02	1700	8.5	35	273X43	380X90
GNL-FB9B(220V)-03	2500	11.0	35	273X43	380X90
GNL-FB9B(110V)-20	1250	4.8	35	273X43	380X90



**GNL-330B-04**  
• ZQF-330B - 风机  
• Rotate Speed:1700(rpm) - 转速  
• Air Volume:5.5(m<sup>3</sup>/min) - 风量  
• Power:35(w) - 功率  
• Outlet Size:330X43(mm) - 外尺寸  
• Install size:380X90(mm) - 安装尺寸



**GNL-FB2B-05**  
• FB-2B - 风机  
• Rotate Speed:1250(rpm) - 转速  
• Air Volume:5.5(m<sup>3</sup>/min) - 风量  
• Power:25(w) - 功率  
• Outlet Size:330X43(mm) - 外尺寸  
• Install size:380X90(mm) - 安装尺寸



**GNL-FB9B-2-06**  
• FB-9B-2 - 风机  
• Rotate Speed:1250(rpm) - 转速  
• Air Volume:6.5(m<sup>3</sup>/min) - 风量  
• Power:25(w) - 功率  
• Outlet Size:350X43(mm) - 外尺寸  
• Install size:420X90(mm) - 安装尺寸



**GNL-FB1042B-07**  
• FB-1042B - 风机  
• Rotate Speed:1350(rpm) - 转速  
• Air Volume:6.5(m<sup>3</sup>/min) - 风量  
• Power:35(w) - 功率  
• Outlet Size:350X43(mm) - 外尺寸  
• Install size:424X70/90(mm) - 安装尺寸



**GNL-FB9K(L)-12**  
• FB-9K(L) - 风机  
• Rotate Speed:1250(rpm) - 转速  
• Air Volume:4.8(m<sup>3</sup>/min) - 风量  
• Power:25(w) - 功率  
• Outlet Size:270X43(mm) - 外尺寸  
• Install size:288X90(m<sup>3</sup>/min) - 安装尺寸



**GNL-FB9K(R)-13**  
• FB-9K(R) - 风机  
• Rotate Speed:1250(rpm) - 转速  
• Air Volume:4.8(m<sup>3</sup>/min) - 风量  
• Power:25(w) - 功率  
• Outlet Size:270X43(mm) - 外尺寸  
• Install size:288X90(mm) - 安装尺寸



**GNL-FB1042B-14**  
• FB-1042B - 风机  
• Rotate Speed:1350(rpm) - 转速  
• Air Volume:6.5(m<sup>3</sup>/min) - 风量  
• Power:35(w) - 功率  
• Outlet Size:430X43(mm) - 外尺寸  
• Install size:446X90(mm) - 安装尺寸



**GNL-FB-1042B-15**  
• FB-1042B - 风机  
• Rotate Speed:1350(rpm) - 转速  
• Air Volume:6(m<sup>3</sup>/min) - 风量  
• Power:35(w) - 功率  
• Outlet Size:330X43(mm) - 外尺寸  
• Install size:424X70(mm) - 安装尺寸



**GNL-FB1042B-J-08**  
• FB-1042B-J - 风机  
• Rotate Speed:1350(rpm) - 转速  
• Air Volume:7(m<sup>3</sup>/min) - 风量  
• Power:35(w) - 功率  
• Outlet Size:420X43(mm) - 外尺寸  
• Install size:446X90(m<sup>3</sup>/min) - 安装尺寸



**GNL-GYQF370-09**  
• GYQF-370 - 风机  
• Rotate Speed:1350(rpm) - 转速  
• Air Volume:6.5(m<sup>3</sup>/min) - 风量  
• Power:35(w) - 功率  
• Outlet Size:350X43(mm) - 外尺寸  
• Install size:424X70/90(mm) - 安装尺寸



**GNL-FB1035B-10**  
• FB-1035B - 风机  
• Rotate Speed:1250(rpm) - 转速  
• Air Volume:6.5(m<sup>3</sup>/min) - 风量  
• Power:25(w) - 功率  
• Outlet Size:360X43(mm) - 外尺寸  
• Install size:380X90(mm) - 安装尺寸



**GNL-FB9B-3-11**  
• FB-9B-3 - 风机  
• Rotate Speed:1250(rpm) - 转速  
• Air Volume:6.5(m<sup>3</sup>/min) - 风量  
• Power:25(w) - 功率  
• Outlet Size:330X43(mm) - 外尺寸  
• Install size:495X90(mm) - 安装尺寸



**GNL-FB1042BH-16**  
• FB-1042BH - 风机  
• Rotate Speed:1350(rpm) - 转速  
• Air Volume:6(m<sup>3</sup>/min) - 风量  
• Power:35(w) - 功率  
• Outlet Size:378X40(mm) - 外尺寸  
• Install size:424X70(m<sup>3</sup>/min) - 安装尺寸



**GNL-FB9B-D-17**  
• FB-9B-D - 风机  
• Rotate Speed:1250(rpm) - 转速  
• Air Volume:5.5(m<sup>3</sup>/min) - 风量  
• Power:25(w) - 功率  
• Outlet Size:360X43(mm) - 外尺寸  
• Install size:380X90(mm) - 安装尺寸



**GNL-XZ352A-18**  
• XZ352A - 风机  
• Rotate Speed:1250(rpm) - 转速  
• Air Volume:7(m<sup>3</sup>/min) - 风量  
• Power:28(w) - 功率  
• Outlet Size:392X34(mm) - 外尺寸  
• Install size:412X90(mm) - 安装尺寸



**GNL-XZ422A-19**  
• XZ422A - 风机  
• Rotate Speed:1250(rpm) - 转速  
• Air Volume:7(m<sup>3</sup>/min) - 风量  
• Power:28(w) - 功率  
• Outlet Size:462X34(mm) - 外尺寸  
• Install size:482X90(mm) - 安装尺寸



**GNL-FB330-21**  
• FB-330 - 风机  
• Rotate Speed:1700(rpm) - 转速  
• Air Volume:5.5(m<sup>3</sup>/min) - 风量  
• Power:35(w) - 功率  
• Outlet Size:330X43(mm) - 外尺寸  
• Install size:380X90(mm) - 安装尺寸



**GNL-QF330-22**  
• QF-330 - 风机  
• Rotate Speed:1700(rpm) - 转速  
• Air Volume:5.5(m<sup>3</sup>/min) - 风量  
• Power:35(w) - 功率  
• Outlet Size:330X43(mm) - 外尺寸  
• Install size:380X90(mm) - 安装尺寸



**GNL-BRB-23**  
• BRB - 风机  
• Rotate Speed:1300(rpm) - 转速  
• Air Volume:6.0(m<sup>3</sup>/min) - 风量  
• Power:45(w) - 功率  
• Install size:300(mm) - 安装尺寸



**GNL-BAB-24**  
• BAB - 风机  
• Rotate Speed:1300(rpm) - 转速  
• Air Volume:6.0(m<sup>3</sup>/min) - 风量  
• Power:45(w) - 功率  
• Install size:300(mm) - 安装尺寸



### ELEVATOR DOOR OPERATER & DOOR HEADER 电梯开门机 & 层门装置



**GNL-DOJMVF-CO**  
 • TWO PANEL VVVF TYPE CENTER OPENING DOOR OPERATOR 异步中分双折开门机  
 • Note: Four panel & Six panel available 注: 可选四折, 六折款式



**GNL-DHJMHV-CO**  
 • TWO PANEL CENTER OPENING DOOR HEADER 中分双折层门装置  
 • Note: Four panel & Six panel available 注: 可选四折, 六折款式



**GNL-DOJMVF-SO**  
 • TWO PANEL VVVF TYPE CENTER OPENING DOOR OPERATOR 异步中分双折开门机  
 • Note: Four panel & Six panel available 注: 可选四折, 六折款式



**GNL-DHJMHV-SO**  
 • TWO PANEL SIDE OPENING DOOR HEADER 旁开双折层门装置  
 • Note: Four panel & Six panel available 注: 可选四折, 六折款式



**GNL-DOSMVF-SO1**  
 • TWO PANEL VVVF TYPE CENTER OPENING DOOR OPERATOR 异步中分双折开门机  
 • Note: Four panel & Six panel available 注: 可选四折, 六折款式



**GNL-DHSMRG-SO**  
 • TWO PANEL SIDE OPENING DOOR HEADER 旁开双折层门装置  
 • Note: Four panel & Six panel available 注: 可选四折, 六折款式

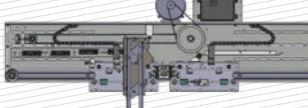

**GNL-DOSMVF-CO1**  
 • TWO PANEL VVVF TYPE CENTER OPENING DOOR OPERATOR 异步中分双折开门机  
 • Note: Four panel & Six panel available 注: 可选四折, 六折款式



**GNL-DHSMRG-CO1**  
 • TWO PANEL CENTER OPENING DOOR HEADER 中分双折层门装置  
 • Note: Four panel & Six panel available 注: 可选四折, 六折款式

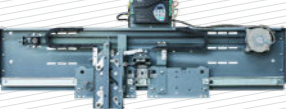

**GNL-DOSMPM-CO**  
 • TWO PANEL PM TYPE CENTER OPENING DOOR OPERATOR 同步中分双折开门机  
 • Note: Four panel & Six panel available 注: 可选四折, 六折款式



**GNL-DHSMRG-CO2**  
 • TWO PANEL CENTER OPENING DOOR HEADER 中分双折层门装置  
 • Note: Four panel & Six panel available 注: 可选四折, 六折款式



**GNL-DOSMVF-SO**  
 • TWO PANEL PM TYPE SIDE OPENING DOOR OPERATOR 同步中分双折开门机  
 • Note: Four panel & Six panel available 注: 可选四折, 六折款式



**GNL-DHSMBO-CO3**  
 • TWO PANEL CENTER OPENING DOOR HEADER 中分双折层门装置  
 • Note: Four panel & Six panel available 注: 可选四折, 六折款式



### ELEVATOR DOOR OPERATER & DOOR HEADER 电梯开门机 & 层门装置



**GNL-OMJ-100A**  
 • TWO PANEL PM TYPE CENTER OPENING DOOR OPERATOR 同步中分双折开门机  
 • Note: Four panel & Six panel available 注: 可选四折, 六折款式



**GNL-OCM01-CD**  
 • TWO PANEL CENTER OPENING DOOR HEADER 中分双折层门装置  
 • Note: Four panel & Six panel available 注: 可选四折, 六折款式



**GNL-OMJ-101A**  
 • TWO PANEL VVVF TYPE CENTER OPENING DOOR OPERATOR 异步中分双折开门机  
 • Note: Four panel & Six panel available 注: 可选四折, 六折款式



**GNL-OCM01-BA**  
 • TWO PANEL CENTER OPENING DOOR HEADER 中分双折层门装置  
 • Note: Four panel & Six panel available 注: 可选四折, 六折款式



**GNL-OMJ-09XA**  
 • TWO PANEL VVVF TYPE CENTER OPENING DOOR OPERATOR 异步中分双折开门机  
 • Note: Four panel & Six panel available 注: 可选四折, 六折款式



**GNL-OCM-01B**  
 • TWO PANEL CENTER OPENING DOOR HEADER 中分双折层门装置  
 • Note: Four panel & Six panel available 注: 可选四折, 六折款式



**GNL-OMJ-102A**  
 • TWO PANEL PM TYPE CENTER OPENING DOOR OPERATOR 同步中分双折开门机  
 • Note: Four panel & Six panel available 注: 可选四折, 六折款式



**GNL-OCM-108D**  
 • TWO PANEL CENTER OPENING DOOR HEADER 中分双折层门装置  
 • Note: Four panel & Six panel available 注: 可选四折, 六折款式



**GNL-OMJ-201A**  
 • FOUR PANEL VVVF TYPE CENTER OPENING DOOR OPERATOR 异步中分四折开门机  
 • Note: Six panel available 注: 可选六折款式



**GNL-OCM-05AX**  
 • FOUR PANEL CENTER OPENING DOOR HEADER 中分四折层门装置  
 • Note: Six panel available 注: 可选六折款式



**GNL-OMJ-02JDX**  
 • TWO PANEL VVVF TYPE SIDE OPENING DOOR HEADER 异步旁开双折层门装置  
 • Note: Single & Four & Six panel available 注: 可选单折, 四折, 六折款式



**GNL-OCM-02AX**  
 • TWO PANEL SIDE OPENING DOOR HEADER 旁开双折层门装置  
 • Note: Four panel & Six panel available 注: 可选四折, 六折款式



**GNL-OMJ-502A**  
 • TWO PANEL PM TYPE SIDE OPENING DOOR HEADER 同步旁开双折层门装置  
 • Note: Single & Four & Six panel available 注: 可选单折, 四折, 六折款式

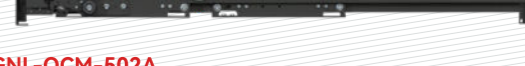

**GNL-OCM-502A**  
 • TWO PANEL SIDE OPENING DOOR HEADER 旁开双折层门装置  
 • Note: Four panel & Six panel available 注: 可选四折, 六折款式

**ELEVATOR DOOR OPERATER & DOOR HEADER**  
电梯开门机 & 层门装置



**ELEVATOR DOOR OPERATER & DOOR HEADER**  
电梯开门机 & 层门装置



**GNL-J5801-C2**  
 • TWO PANEL PM TYPE CENTER OPENING DOOR OPERATOR 异步中分双折开门机  
 • Note: Four panel & Six panel available 注: 可选四折, 六折款式

**GNL-T3200-C2**  
 • TWO PANEL CENTER OPENING DOOR OPERATOR 中分双折开门机  
 • Note: Four panel & Six panel available 注: 可选四折, 六折款式

**GNL-J4210-T2**  
 • TWO PANEL PM TYPE SIDE OPENING DOOR OPERATOR 异步旁开双折开门机  
 • Note: Single & Four & Six panel available 注: 可选单折, 四折, 六折款式

**GNL-T4210-T2**  
 • TWO PANEL SIDE OPENING DOOR OPERATOR 旁开双折层门装置  
 • Note: Single & Four & Six panel available 注: 可选单折, 四折, 六折款式

**GNL-J2511-C2A**  
 • TWO PANEL PM TYPE CENTER OPENING DOOR OPERATOR 异步中分双折开门机  
 • Note: Four panel & Six panel available 注: 可选四折, 六折款式

**GNL-T2200-C2A**  
 • TWO PANEL CENTER OPENING DOOR HEADER 中分双折层门装置  
 • Note: Four panel & Six panel available 注: 可选四折, 六折款式

**GNL-J2511-T2A**  
 • TWO PANEL PM TYPE SIDE OPENING DOOR OPERATOR 异步旁开双折开门机  
 • Note: Single & Four & Six panel available 注: 可选单折, 四折, 六折款式

**GNL-T2200-T2A**  
 • TWO PANEL SIDE OPENING DOOR HEADER 旁开双折层门装置  
 • Note: Single & Four & Six panel available 注: 可选单折, 四折, 六折款式

**GNL-J2511-C2B**  
 • TWO PANEL PM TYPE CENTER OPENING GLASS DOOR OPERATOR 异步中分双折玻璃门开门机  
 • Note: Four panel & Six panel available 注: 可选四折, 六折款式

**GNL-T2200-C2B**  
 • TWO PANEL CENTER OPENING GLASS DOOR HEADER 中分双折玻璃门层门装置  
 • Note: Four panel & Six panel available 注: 可选四折, 六折款式

**GNL-J2511-T2B**  
 • TWO PANEL PM TYPE SIDE OPENING GLASS DOOR OPERATOR 异步旁开双折玻璃门开门机  
 • Note: Four panel & Six panel available 注: 可选单折, 四折, 六折款式

**GNL-T2200-T2B**  
 • TWO PANEL SIDE OPENING GLASS DOOR HEADER 旁开双折玻璃门层门装置  
 • Note: Four panel & Six panel available 注: 可选单折, 四折, 六折款式

**GNL-MS211**  
 • TWO PANEL VVVF TYPE CENTER OPENING DOOR OPERATOR 异步中分双折开门机  
 • Note: Four panel & Six panel available 注: 可选四折, 六折款式

**GNL-MS111**  
 • TWO PANEL CENTER OPENING DOOR HEADER 中分双折层门装置  
 • Note: Four panel & Six panel available 注: 可选四折, 六折款式

**GNL-MS202**  
 • TWO PANEL VVVF TYPE CENTER OPENING DOOR OPERATOR 异步旁开双折开门机  
 • Note: Single & Four & Six panel available 注: 可选单折, 四折, 六折款式

**GNL-MS102**  
 • TWO PANEL SIDE OPENING DOOR HEADER 旁开双折层门装置  
 • Note: Single & Four & Six panel available 注: 可选单折, 四折, 六折款式

**GNL-KS211**  
 • TWO PANEL PM TYPE CENTER OPENING DOOR OPERATOR 同步中分双折开门机  
 • Note: Four panel & Six panel available 注: 可选四折, 六折款式

**GNL-KS111**  
 • TWO PANEL CENTER OPENING DOOR HEADER 中分双折层门装置  
 • Note: Four panel & Six panel available 注: 可选四折, 六折款式

**GNL-KS202**  
 • TWO PANEL PM TYPE SIDE OPENING DOOR OPERATOR 同步旁开双折开门机  
 • Note: Single & Four & Six panel available 注: 可选单折, 四折, 六折款式

**GNL-KS102**  
 • TWO PANEL SIDE OPENING DOOR HEADER 旁开双折层门装置  
 • Note: Single & Four & Six panel available 注: 可选单折, 四折, 六折款式



### ELEVATOR DOOR VANE 电梯门刀



### ELEVATOR DOOR LOCK 电梯门锁

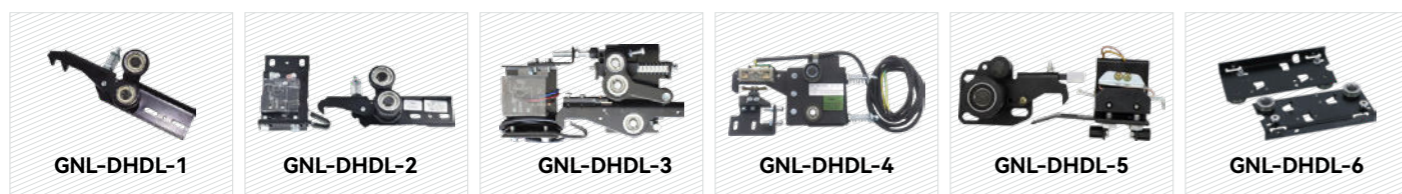

### ELEVATOR DOOR MOTOR 电梯门机



### ELEVATOR DOOR INVERTER 电梯门机变频器



### ELEVATOR OTHERS 电梯其它配件



### ELEVATOR DOOR ROLLER 电梯门挂轮



### ELEVATOR DOOR CONTACT 电梯门触点





ELEVATOR GEARLESS MOTOR 电梯无齿轮曳引机

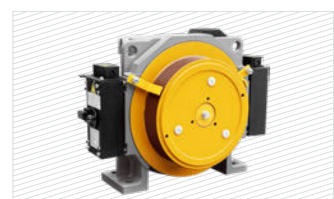

<b>GNL-GTW7A</b>	
Load Capacity 载重: 320-630kg	
Suspension 曳引比	2:1
Voltage 电压	380V
Pole 极	32
FZD10 Brake 制动器	DC110V 2x0.84A
Max.Static Load 最大静态负载	2000kg



<b>GNL-GTW9S</b>	
Load Capacity 载重: 630-1150kg	
Suspension 曳引比	2:1/1:1
Voltage 电压	380V
Pole 极	32
FZD12AB Brake 制动器	DC110V 2x1.28A
Max.Static Load 最大静态负载	3000kg



<b>GNL-GTW10X</b>	
Load Capacity 载重: 1350-1600kg	
Suspension 曳引比	2:1/4:1/1:1
Voltage 电压	380V
Pole 极	32
FZD14 Brake 制动器	DC110V 2x2A
Max.Static Load 最大静态负载	6000kg



<b>GNL-GTW12</b>	
Load Capacity 载重: 2000-2500kg	
Suspension 曳引比	2:1/4:1/1:1
Voltage 电压	380V
Pole 极	32
FZD14 Brake 制动器	DC110V 2x2A
Max.Static Load 最大静态负载	6000kg



<b>GNL-ERSL</b>	
Load Capacity 载重: 320-630kg	
Suspension 曳引比	2:1
Voltage 电压	380V
Pole 极	20
FZI400B Brake 制动器	DC110V 2x1.41A
Max.Static Load 最大静态负载	2000kg



<b>GNL-ER1L</b>	
Load Capacity 载重: 630-1150kg	
Suspension 曳引比	2:1
Voltage 电压	380V
Pole 极	20
FZI400B Brake 制动器	DC110V 2x0.9A
Max.Static Load 最大静态负载	3500kg



<b>GNL-ER5</b>	
Load Capacity 载重: 1150-1600kg	
Suspension 曳引比	2:1
Voltage 电压	380V
Pole 极	32
FZI400B Brake 制动器	DC110V 2x2.1A
Max.Static Load 最大静态负载	5500kg



<b>GNL-ER6D</b>	
Load Capacity 载重: 1250-2500kg	
Suspension 曳引比	2:1
Voltage 电压	380V
Pole 极	20
FZI400B Brake 制动器	DC110V 2x2.1A
Max.Static Load 最大静态负载	6000kg



<b>GNL-GTNH2</b>	
Load Capacity 载重: 1000-2000kg	
Suspension 曳引比	2:1
Voltage 电压	380V
Pole 极	20
PZD140B Brake 制动器	DC110V 2x0.89A
PZD140 Brake 制动器	DC110V 4x0.69A
Max.Static Load 最大静态负载	2000kg



<b>GNL-GTN2C</b>	
Load Capacity 载重: 630-1150kg	
Suspension 曳引比	2:1
Voltage 电压	380V
Pole 极	32
PZD360 Brake 制动器	DC110V 2x2.2A
Max.Static Load 最大静态负载	3500kg

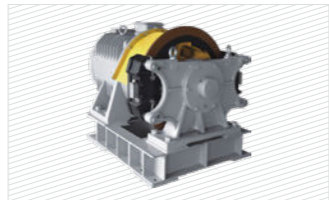

<b>GNL-GTN3</b>	
Load Capacity 载重: 1600-2000kg	
Suspension 曳引比	1:1
Voltage 电压	380V
Pole 极	24
PZD360 Brake 制动器	DC110V 2x2.2A
Max.Static Load 最大静态负载	36000kg

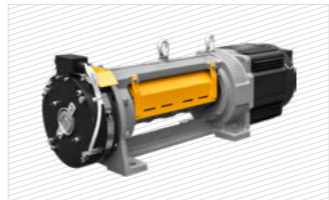

<b>GNL-BPM1000</b>	
Load Capacity 载重: 1250-2500kg	
Suspension 曳引比	2:1
Voltage 电压	380V
Pole 极	8
PZ300C Brake 制动器	DC110V 1.9A
Max.Static Load 最大静态负载	2500kg

ELEVATOR GEARED MOTOR 电梯有齿轮曳引机



<b>GNL-YJ150</b>	
Load Capacity 载重: 630-750kg	
Suspension 曳引比	1:1
Max.Static Load 最大静态负载	3500kg
Control 控制方式	VVVF
DZE-9EA Brake DZE-9EA 制动器	DC110V 1.5A



<b>GNL-YJ200A</b>	
Load Capacity 载重: 630-1000kg	
Suspension 曳引比	1:1
Max.Static Load 最大静态负载	6000kg
Control 控制方式	VVVF
DZE-9EA Brake DZE-9EA 制动器	DC110V 1.5A



<b>GNL-YJ250A</b>	
Load Capacity 载重: 1150-1500kg	
Suspension 曳引比	1:1
Max.Static Load 最大静态负载	7000kg
Control 控制方式	VVVF
DZE-9EA Brake DZE-9EA 制动器	DC110V 2A



<b>GNL-YJ275A</b>	
Load Capacity 载重: 1350-1600kg	
Suspension 曳引比	1:1
Max.Static Load 最大静态负载	9000kg
Control 控制方式	VVVF
DZE-9EA Brake DZE-9EA 制动器	DC110V 2A

ELEVATOR MOTRO BASE & COUNTER PARTS 电梯曳引机架 & 对重架

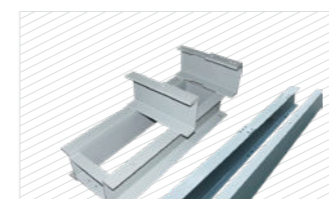

MR MOTOR BASE  
有机房机架

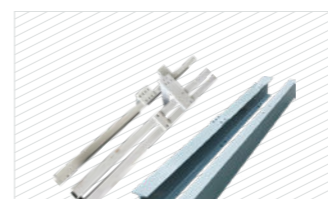

MRL MOTOR BASE  
无机房机架



COUNTER WEIGHT FRAME  
对重架



COUNTER WEIGHT FRAME  
对重架



MAGENT VANE  
隔磁板



ELEVATOR LINE SLOT  
线槽

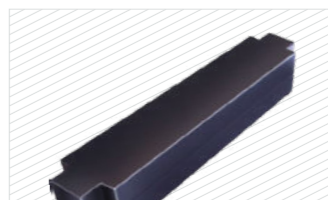

COUNTER WEIGHT BLOCK  
对重块

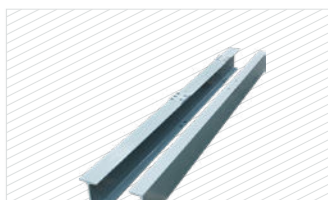

LOAD BEAM  
承重梁

ELEVATOR DAMPING PAD 电梯减震垫



GNL-DAPR-1



GNL-DAPR-2



GNL-DAPR-3

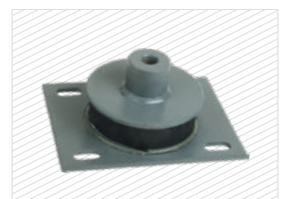

GNL-DAPR-4



GNL-DAPR-5



GNL-DAPR-6



GNL-DAPR-7



GNL-DAPR-8



GNL-DAPR-9



GNL-DAPR-10

ELEVATOR ENCODER 电梯编码器



1387 ENCODER  
1387 编码器



1387 ENCODER CABLE  
1387 编码器线



1313 ENCODER  
1313 编码器



1024 ENCODER  
1024 编码器



1024 ENCODER CABLE  
1024 编码器线

## ELEVATOR STEEL WIRE ROPE 电梯钢丝绳



MODEL 型号	NOMINAL ROPE DIAMETER 绳径	APPROX WEIGHT 提升重量	MINIMUM BREAKING LOAD 制动载重					
			DUAL TENSILE MPA 双向涨紧			SINGLE TENSILE MPA 单向涨紧		
			1320/1620 1320/1770	1370/1770	1570/1770 1620/1770	1570	1620	1770
	MM	KG/100M	KN	KN	KN	KN	KN	KN
GNL-NFSR-6	6/6.5	13.5	16.4	17.4	19.1	18.3	18.8	20.6
GNL-NFSR-8	8	21.8	26.5	28.1	30.8	29.4	30.4	33.2
GNL-NFSR-10	10	34	41.3	44	48.1	46	47.5	51.9
GNL-NFSR-12	12	49	59.5	63.3	69.2	66.2	68.4	74.7
GNL-NFSR-13	13	57.5	69.8	74.3	81.2	77.7	80.2	87.6
GNL-NFSR-14	14	66.6	81	86.1	94.2	90.2	93	102

## ELEVATOR CABLE 电梯电缆线

MODEL 型号	TYPE 规格	DETAILS 细节
GNL-TVVB24-75	TVVB24x075	24 Core Flat Traveling Cable/24 芯随行电缆
GNL-TVVB48-75	TVVB48x075	48 Core Flat Traveling Cable/48 芯随行电缆
GNL-RVV-12-75	RVV12x075	12 Core Round Cable/12 芯圆形电缆
GNL-RVV-3-75	RVV3x0.75	3 Core Round Cable/3 芯圆形电缆
GNL-RVVP-2P2-75	RVVP2x*2Px0.75	4 Core Round Cable/4 芯圆形电缆
GNL-RVV-4-75	RVV4x4	4 Core Power Cable / 4 芯电源电缆



## ELEVATOR CABLE CLAMP 电梯电缆夹



## ELEVATOR NYLON PULLEY 电梯尼龙轮



MODEL 型号	PULLEY DIAMETER 轮径	ROPE DIAMETER 绳径	ROPE LINE (GROOVE) 槽数	SHAFT DIAMETER 轴径	SHAFT LENGTH 轴长
GNL-PUW-1	320 MM	8 MM	4 LINE	50 MM	300 MM
GNL-PUW-2	320 MM	8 MM	5 LINE	50 MM	300 MM
GNL-PUW-3	320 MM	8 MM	4 LINE	60 MM	300 MM
GNL-PUW-4	320 MM	8 MM	5 LINE	60 MM	300 MM
GNL-PUW-5	320 MM	8 MM	4 LINE	60 MM	600 MM
GNL-PUW-6	320 MM	8 MM	5 LINE	60 MM	600 MM
GNL-PUW-7	320 MM	10 MM	4 LINE	50 MM	300 MM
GNL-PUW-8	320 MM	10 MM	5 LINE	50 MM	300 MM
GNL-PUW-9	320 MM	10 MM	4 LINE	60 MM	300 MM
GNL-PUW-10	320 MM	10 MM	5 LINE	60 MM	300 MM
GNL-PUW-11	320 MM	10 MM	4 LINE	60 MM	600 MM
GNL-PUW-12	320 MM	10 MM	5 LINE	60 MM	600 MM
GNL-PUW-13	400 MM	8 MM	4 LINE	50 MM	300 MM
GNL-PUW-14	400 MM	8 MM	5 LINE	50 MM	300 MM
GNL-PUW-15	400 MM	8 MM	4 LINE	60 MM	300 MM
GNL-PUW-16	400 MM	8 MM	5 LINE	60 MM	300 MM
GNL-PUW-17	400 MM	8 MM	4 LINE	60 MM	600 MM
GNL-PUW-18	400 MM	8 MM	5 LINE	60 MM	600 MM
GNL-PUW-19	400 MM	10 MM	4 LINE	50 MM	300 MM
GNL-PUW-20	400 MM	10 MM	5 LINE	50 MM	300 MM
GNL-PUW-21	400 MM	10 MM	4 LINE	60 MM	300 MM
GNL-PUW-22	400 MM	10 MM	5 LINE	60 MM	300 MM
GNL-PUW-23	400 MM	10 MM	4 LINE	60 MM	600 MM
GNL-PUW-24	400 MM	10 MM	5 LINE	60 MM	600 MM

## ELEVATOR ROPE FASTENING / 电梯绳头组合

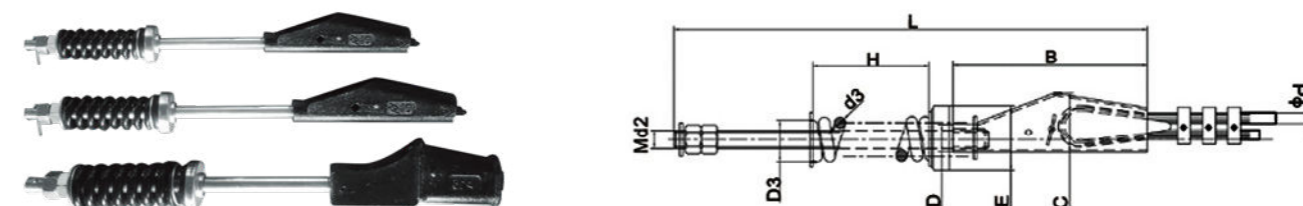

### ELEVATOR SPRING TYPE ROPE FASTENING 电梯弹簧式绳头组合

MODEL 型号	DESCRIPTION 直径	L(MM)	B(MM)	C(MM)	D(MM)	MD2 (MM)
GNLRF-1	8MM	375	160	48	φ26	M14
GNLRF-2	9MM	395	180	54	φ26	M14
GNLRF-3	10MM	490	180	54	φ26	M16
GNLRF-4	11MM	490	180	54	φ26	M16
GNLRF-5	12MM	510	200	60	φ26	M16
GNLRF-6	13MM	580	218	62	φ30	M18
GNLRF-7	16MM	620	190	76	φ22	M20



### ELEVATOR RUBBER TYPE ROPE FASTENING 电梯橡胶式绳头组合

MODEL 型号	DESCRIPTION 直径	L(MM)	B(MM)	C(MM)	D(MM)	MD2 (MM)
GNLRF-8	8MM	375	160	48	φ26	M14
GNLRF-9	10MM	490	180	54	φ26	M16
GNLRF-10	12MM & 13MM	580	218	62	φ30	M20

### ELEVATOR FLEXIBLE TYPE ROPE FASTENING 电梯伸缩式绳头组合

MODEL 型号	DESCRIPTION 直径	L(MM)	B(MM)	C(MM)	D(MM)	MD2 (MM)
GNLRF-11	6MM	435	150	45	φ26	M14
GNLRF-12	8MM	435	150	45	φ26	M14
GNLRF-13	9MM	510	180	57	φ26	M16
GNLRF-14	10MM	510	180	57	φ26	M16
GNLRF-15	11MM	510	180	57	φ26	M16
GNLRF-16	12MM & 13MM	595	230	74	φ30	M20

### REGULAR ROPE CLIP 常规绳夹



### ROPE U CLIP / U 形绳夹





◆ ELEVATOR OIL BUFFER 电梯油压缓冲器

MODEL 型号	SPEED (M/S) 速度 (M/S)	LOAD(P+Q)(KG) 载重 (P+Q)(KG)	HEIGHT(MM) 高度 (MM)
GNL-OIL-80	≤ 1.00	600 ~ 3800	270
GNL-OIL-175	≤ 1.50	600 ~ 3800	526
GNL-OIL-210	≤ 1.75	600 ~ 3800	596
GNL-OIL-275	≤ 2.00	600 ~ 3800	746
GNL-OIL-425	≤ 2.50	600 ~ 3800	1111

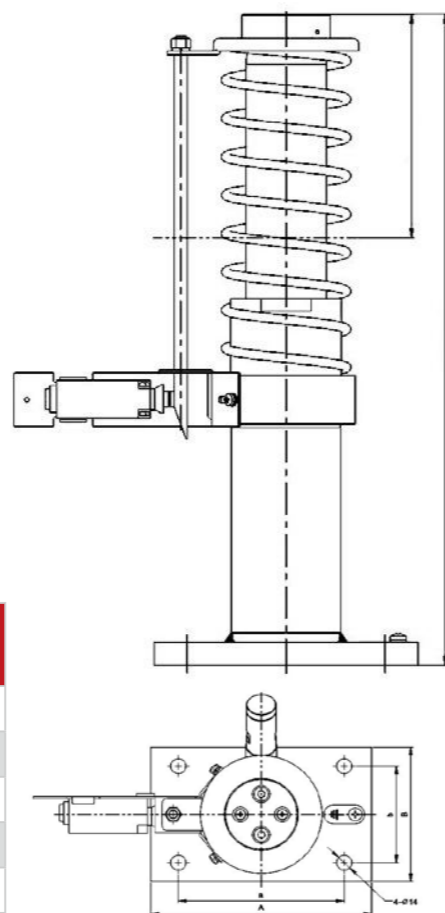

◆ ELEVATOR PU BUFFER 电梯聚氨酯缓冲器

TYPE 型号	SIZE 尺寸	WEIGHT 载重 (P+Q KG)	INSTALL SIZE 安装尺寸			SPEED 速度
	D*H		B	b	h	
GNLPUB-1	65*80	200-1200	95	65	4	≤ 1.0m/s
GNLPUB-2	80*80	200-1200	108	80	4	≤ 1.0m/s
GNLPUB-3	80*100	200-2000	108	80	4	≤ 1.0m/s
GNLPUB-4	80*128	200-2000	108	80	4	≤ 1.0m/s
GNLPUB-5	100*80	500-2000	128	96	4	≤ 1.0m/s
GNLPUB-6	100*100	500-2200	128	96	4	≤ 1.0m/s
GNLPUB-7	100*120	200-2500	128	96	4	≤ 1.0m/s

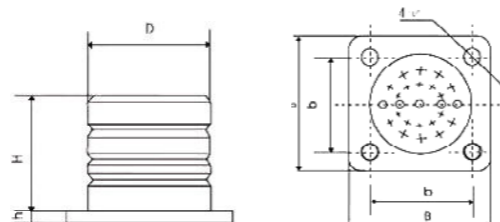

◆ ELEVATOR OVER SPEED GOVERNOR 电梯限速器

Elevator speed governor, monitor and control the speed of the cabin at any time, when an overspeed situation occurs, at 115% of the rated speed of the elevator, being able to send out signals in a timely manner, subsequently, a mechanical action is generated to cut off the power supply circuit, brake the traction machine. If the elevator still cannot brake, the safety gear installed at the bottom of the cabin will forcibly stop the cabin.



**GNL-OSG-S**  
 • SPEED GOVERNOR (SINGLE)  
 • 单向限速器  
 • SPEED 速度 :1M/S, 1.5M/S

**GNL-OSG-TD**  
 • TENSION DEVICE  
 • 涨紧装置  
 • WEIGHT 重量 :18KG OR 30KG



**GNL-OSG-D**  
 • MR SPEED GOVERNOR (DOUBLE)  
 • 有机房双向限速器



**GNL-OSG-S2**  
 • MR SPEED GOVERNOR (SINGLE/DOUBLE)  
 • 有机房限速器 (单向 / 双向)



**GNL-OSG-S3**  
 • MRL SPEED GOVERNOR (SINGLE/DOUBLE)  
 • 无机房限速器 (单向 / 双向)



**GNL-OSG-S4**  
 • MRL SPEED GOVERNOR (SINGLE/DOUBLE)  
 • 无机房限速器 (单向 / 双向)

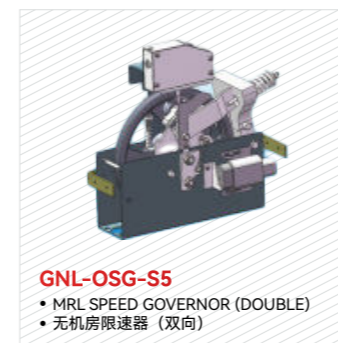

**GNL-OSG-S5**  
 • MRL SPEED GOVERNOR (DOUBLE)  
 • 无机房限速器 (双向)



**GNL-OSG-S6**  
 • MRL SPEED GOVERNOR (SINGLE/DOUBLE)  
 • 无机房限速器 (单向 / 双向)



**GNL-OSG-S7**  
 • MRL SPEED GOVERNOR (SINGLE/DOUBLE)  
 • 无机房限速器 (单向 / 双向)



**GNL-OSG-S8**  
 • MRL SPEED GOVERNOR (SINGLE/DOUBLE)  
 • 无机房限速器 (单向 / 双向)



**GNL-OSG-TDS1**  
 • TENSION DEVICE  
 • 涨紧装置

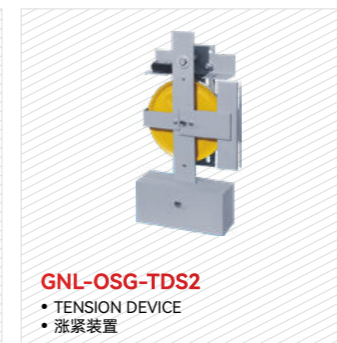

**GNL-OSG-TDS2**  
 • TENSION DEVICE  
 • 涨紧装置



**GNL-OSG-TDS3**  
 • TENSION DEVICE  
 • 涨紧装置



**GNL-OSG-TDS4**  
 • TENSION DEVICE  
 • 涨紧装置

ELEVATOR SAFETY GEAR SET 电梯安全钳

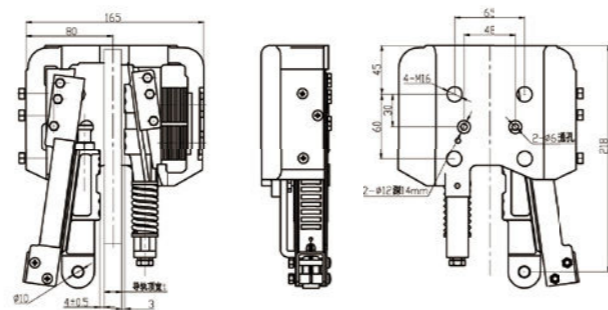

GNL-SFGR-1



GNL-SFGR-2



GNL-SFGR-3



GNL-SFGR-4



GNL-SFGR-5

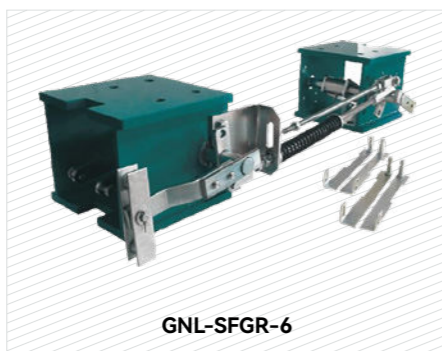

GNL-SFGR-6



GNL-SFGR-7



GNL-SFGR-8



GNL-SFGR-9



GNL-SFGR-10

ELEVATOR OIL BOX 电梯油杯



GNL-OB-1



GNL-OB-2



GNL-OB-3



GNL-OB-4



GNL-OB-5



GNL-OB-6



GNL-OB-7



GNL-OB-8



GNL-OB-9



GNL-OB-10



GNL-OB-11



GNL-OB-12

ELEVATOR SWITCH & POWER BOX 电梯开关 & 电源盒



MODEL:GNL-CTIBW-1



MODEL:GNL-PTIBW-1



MODEL:GNL-EMSSB-1



SWITCH BOX 开关盒



POWER BOX 电源盒



POWER BOX 电源盒

ELEVATOR SOLID GUIDE RAIL 电梯实心导轨













Model	Type	Rail Type
GNL-T70-1/B	T70-1/B	9 MM Type Solid Guide Rail
GNL-T70-4/B	T70-4/B	9 MM Type Solid Guide Rail
GNL-T75/B	T75/B	10 MM Type Solid Guide Rail
GNL-T75-3/B	T75-3/B	10 MM Type Solid Guide Rail
GNL-T75-4/B	T75-4/B	10 MM Type Solid Guide Rail
GNL-T78/B	T78/B	10 MM Type Solid Guide Rail
GNL-T82/B	T82/B	9 MM Type Solid Guide Rail
GNL-T82-1/B	T82-1/B	9 MM Type Solid Guide Rail
GNL-T82-3/B	T82-3/B	15.88 MM Type Solid Guide Rail
GNL-T82-4/B	T82-4/B	10 MM Type Solid Guide Rail
GNL-T89/B	T89/B	16 MM Type Solid Guide Rail
GNL-T89-1/B	T89-1/B	15.88 MM Type Solid Guide Rail
GNL-T89-2/B	T89-2/B	10 MM Type Solid Guide Rail
GNL-T90/B	T90/B	16 MM Type Solid Guide Rail
GNL-T114/B	T114/B	16 MM Type Solid Guide Rail
GNL-T125/B	T125/B	16 MM Type Solid Guide Rail
GNL-T127-1/B	T127-1/B	16 MM Type Solid Guide Rail
GNL-T127-2/B	T127-2/B	16 MM Type Solid Guide Rail
GNL-T140-1/B	T140-1/B	19 MM Type Solid Guide Rail
GNL-T140-2/B	T140-2/B	28.6 MM Type Solid Guide Rail
GNL-T140-3/B	T140-3/B	31.75 MM Type Solid Guide Rail



ELEVATOR HOLLOW GUIDE RAIL 电梯空心导轨

Type	Model	Rail Type
TK3A-2.3	GNL-TK3A-2.3	16.4 MM Type Hollow Guide Rail
TK5A-3.2	GNL-TK5A-3.2	16.4 MM Type Hollow Guide Rail
TK5A-3.0	GNL-TK5A-3.0	16.4 MM Type Hollow Guide Rail
TK5A-2.75	GNL-TK5A-2.75	16.4 MM Type Hollow Guide Rail

ELEVATOR GUIDE RAIL SUPPORTING PARTS 电梯导轨组配件

 T-Clips T型压导板	 Arc Forged Clips 弧形锻造压导板	 Forged Clip 锻造压导板	 Stretch Clip BL 弹性压导板
 Fish Plate 导轨连接板	 Hollow Guide Rail Fish Plate 空心导轨连接板	 U-Fishplate U型连接板	 Z-Fishplate Z型连接板
 ELEVATOR ANCHOR BOLT 膨胀螺栓	 ELEVATOR ANCHOR BOLT 膨胀螺栓	 Rail Bracket 导轨支架	 Hollow Guide Rail BL BL 封闭空轨

ELEVATOR GUIDE SHOE 电梯导靴

 GNL-GS-1	 GNL-GS-2	 GNL-GS-3	 GNL-GS-4	 GNL-GS-5
 GNL-GS-6	 GNL-GS-7	 GNL-GS-8	 GNL-GS-9	 GNL-GS-10
 GNL-GS-11	 GNL-GS-12	 GNL-GS-13	 GNL-GS-14	 GNL-GS-15
 GNL-GS-16	 GNL-GS-17	 GNL-GS-18	 GNL-GS-19	 GNL-GS-20
 GNL-GS-21	 GNL-GS-22	 GNL-GS-23	 GNL-GS-24	 GNL-GS-25

ELEVATOR ROLLER GUIDE SHOE 电梯滚轮导靴

 GNL-RGS-1	 GNL-RGS-2	 GNL-RGS-3	 GNL-RGS-4	 GNL-RGS-5
--	--	--	--	--

# Monarch

by INOVANCE



## MONARCH ARD 电梯自动救援装置



MODEL(型号)	POWER (KW) 功率	PHASE (相)	VOLTAGE (电压)
GNL-MCTC-ARD-C-0P6-18A-HC	5.5-7.5KW	3 PHASE	380V
GNL-MCTC-ARD-C-0P8-32A-HC	11-15KW	3 PHASE	380V
GNL-MCTC-ARD-C-0P8-50A-HC	18.5-22KW	3 PHASE	380V
GNL-MCTC-ARD-C-1P6-18A-HC	5.5-7.5KW	3 PHASE	380V
GNL-MCTC-ARD-C-1P6-32A-HC	11-15KW	3 PHASE	380V
GNL-MCTC-ARD-C-1P6-65A-HC	30KW	3 PHASE	380V
GNL-MCTC-ARD-C-1P6-80A-HC	37KW	3 PHASE	380V

## NICE 2000 NEW INVERTER 变频器



MODEL(型号)	POWER (KW) 功率	PHASE (相)	VOLTAGE (电压)
GNL-NICE-E1-B-4013	5.5 KW	3 PHASE	380 V
GNL-NICE-E1-B-4017	7.5 KW	3 PHASE	380 V
GNL-NICE-E1-B-4025	11 KW	3 PHASE	380 V
GNL-NICE-E1-B-4032	15 KW	3 PHASE	380 V
GNL-NICE-E1-B-4037	18.5 KW	3 PHASE	380 V
GNL-NICE-E1-B-4045	22 KW	3 PHASE	380 V
GNL-NICE-E1-B-4060	30 KW	3 PHASE	380 V

## NICE 3000 NEW INVERTER 变频器



MODEL(型号)	POWER (KW) 功率	PHASE (相)	VOLTAGE (电压)
GNL-NICE-L-C-4003	3.7 KW	3 PHASE	220V/380 V
GNL-NICE-L-C-4005	5.5 KW	3 PHASE	220V/380 V
GNL-NICE-L-C-4007	7.5 KW	3 PHASE	220V/380 V
GNL-NICE-L-C-4011	11 KW	3 PHASE	220V/380 V
GNL-NICE-L-C-4015	15 KW	3 PHASE	220V/380 V
GNL-NICE-L-C-4018	18.5 KW	3 PHASE	220V/380 V
GNL-NICE-L-C-4022	22 KW	3 PHASE	220V/380 V
GNL-NICE-L-C-4030	30 KW	3 PHASE	220V/380 V
GNL-NICE-L-C-4037	37 KW	3 PHASE	220V/380 V
GNL-NICE-L-C-4045	45 KW	3 PHASE	220V/380 V
GNL-NICE-L-C-4055	55 KW	3 PHASE	220V/380 V
GNL-NICE-L-C-4075	75 KW	3 PHASE	220V/380 V
GNL-NICE-L-C-4090	90 KW	3 PHASE	220V/380 V

## NICE 1000 NEW INVERTER 变频器



MODEL(型号)	POWER (KW) 功率	PHASE (相)	VOLTAGE (电压)
GNL-NICE-L-H-4002	2.2 KW	3 PHASE	220V/380 V
GNL-NICE-L-H-4003	3.7 KW	3 PHASE	220V/380 V
GNL-NICE-L-H-4005	5.5 KW	3 PHASE	220V/380 V
GNL-NICE-L-H-4007	7.5 KW	3 PHASE	220V/380 V
GNL-NICE-L-H-4011	11 KW	3 PHASE	220V/380 V
GNL-NICE-L-H-4015	15 KW	3 PHASE	220V/380 V
GNL-NICE-L-H-4018	18.5 KW	3 PHASE	220V/380 V
GNL-NICE-L-H-4022	22 KW	3 PHASE	220V/380 V
GNL-NICE-L-H-4030	30 KW	3 PHASE	220V/380 V
GNL-NICE-L-H-4037	37 KW	3 PHASE	220V/380 V
GNL-NICE-L-H-4045	45 KW	3 PHASE	220V/380 V
GNL-NICE-L-H-4055	55 KW	3 PHASE	220V/380 V



## NICE 3000 NEW MR CONTROLLER 有机房控制柜

MODEL(型号)	POWER (KW) 功率	PHASE (相)	VOLTAGE (电压)
GNL-N3KCNTL-03MR	3.7 KW	3 PHASE	220V/380 V
GNL-N3KCNTL-05MR	5.5 KW	3 PHASE	220V/380 V
GNL-N3KCNTL-07MR	7.5 KW	3 PHASE	220V/380 V
GNL-N3KCNTL-11MR	11 KW	3 PHASE	220V/380 V
GNL-N3KCNTL-15MR	15 KW	3 PHASE	220V/380 V
GNL-N3KCNTL-18MR	18.5 KW	3 PHASE	220V/380 V
GNL-N3KCNTL-22MR	22 KW	3 PHASE	220V/380 V
GNL-N3KCNTL-30MR	30 KW	3 PHASE	220V/380 V
GNL-N3KCNTL-37MR	37 KW	3 PHASE	220V/380 V
GNL-N3KCNTL-45MR	45 KW	3 PHASE	220V/380 V
GNL-N3KCNTL-55MR	55 KW	3 PHASE	220V/380 V
GNL-N3KCNTL-75MR	75 KW	3 PHASE	220V/380 V
GNL-N3KCNTL-90MR	90 KW	3 PHASE	220V/380 V

## NICE 3000 NEW MRL CONTROLLER 无机房控制柜

MODEL(型号)	POWER (KW) 功率	PHASE (相)	VOLTAGE (电压)
GNL-N3KCNTL-03MRL	3.7 KW	3 PHASE	220V/380 V
GNL-N3KCNTL-05MRL	5.5 KW	3 PHASE	220V/380 V
GNL-N3KCNTL-07MRL	7.5 KW	3 PHASE	220V/380 V
GNL-N3KCNTL-11MRL	11 KW	3 PHASE	220V/380 V
GNL-N3KCNTL-15MRL	15 KW	3 PHASE	220V/380 V
GNL-N3KCNTL-18MRL	18.5 KW	3 PHASE	220V/380 V
GNL-N3KCNTL-22MRL	22 KW	3 PHASE	220V/380 V
GNL-N3KCNTL-30MRL	30 KW	3 PHASE	220V/380 V
GNL-N3KCNTL-37MRL	37 KW	3 PHASE	220V/380 V
GNL-N3KCNTL-45MRL	45 KW	3 PHASE	220V/380 V
GNL-N3KCNTL-55MRL	55 KW	3 PHASE	220V/380 V
GNL-N3KCNTL-75MRL	75 KW	3 PHASE	220V/380 V
GNL-N3KCNTL-90MRL	90 KW	3 PHASE	220V/380 V

## NICE 900 DOOR INVERTER 门机变频器



MODEL(型号)	POWER (W) 功率	PHASE (相)	VOLTAGE (电压)
GNL-NICE-DA/F-SOP2	200 WATT	1 PHASE	220 V
GNL-NICE-A/F-SOP4	400 WATT	1 PHASE	220 V
GNL-NICE-A/F-SOP7	750 WATT	1 PHASE	220 V

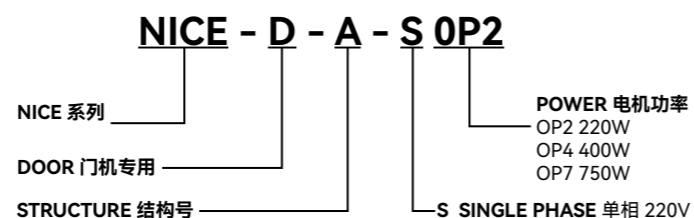

### INVERTER MOTHER BOARD 变频器主板



### PG CARD 卡



### CCB & CTB CONNECTION 连接板



### ELEVATOR RESISTANCE 电梯波纹电阻

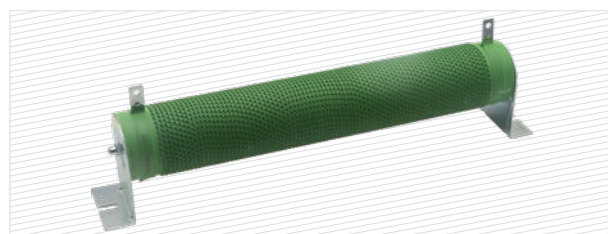

MODEL 型号	WATT 功率 (W)	OHM 电阻 (Ω)	SIZE 尺寸 (MM)						
			L±2	L1±2	L2±2	H±2	D±1	G±1	b
GNL-RES-1.6KW	1600	90	430	465	490	130	70	6.5	69
GNL-RES-2KW	2000	60	430	465	490	130	70	6.5	69
GNL-RES-2.5KW	2500	65	430	465	490	130	70	6.5	69
GNL-RES-3.5KW	3500	43	430	465	490	130	70	6.5	69
GNL-RES-4.5KW	4500	35	500	535	560	130	90	8.5	89

### INVERTER IGBT 变频器模块



### ELEVATOR MODERNIZATION PLAN WITH MONARCH CONTROL SYSTEM 电梯现代化改造清单和默纳克控制系统

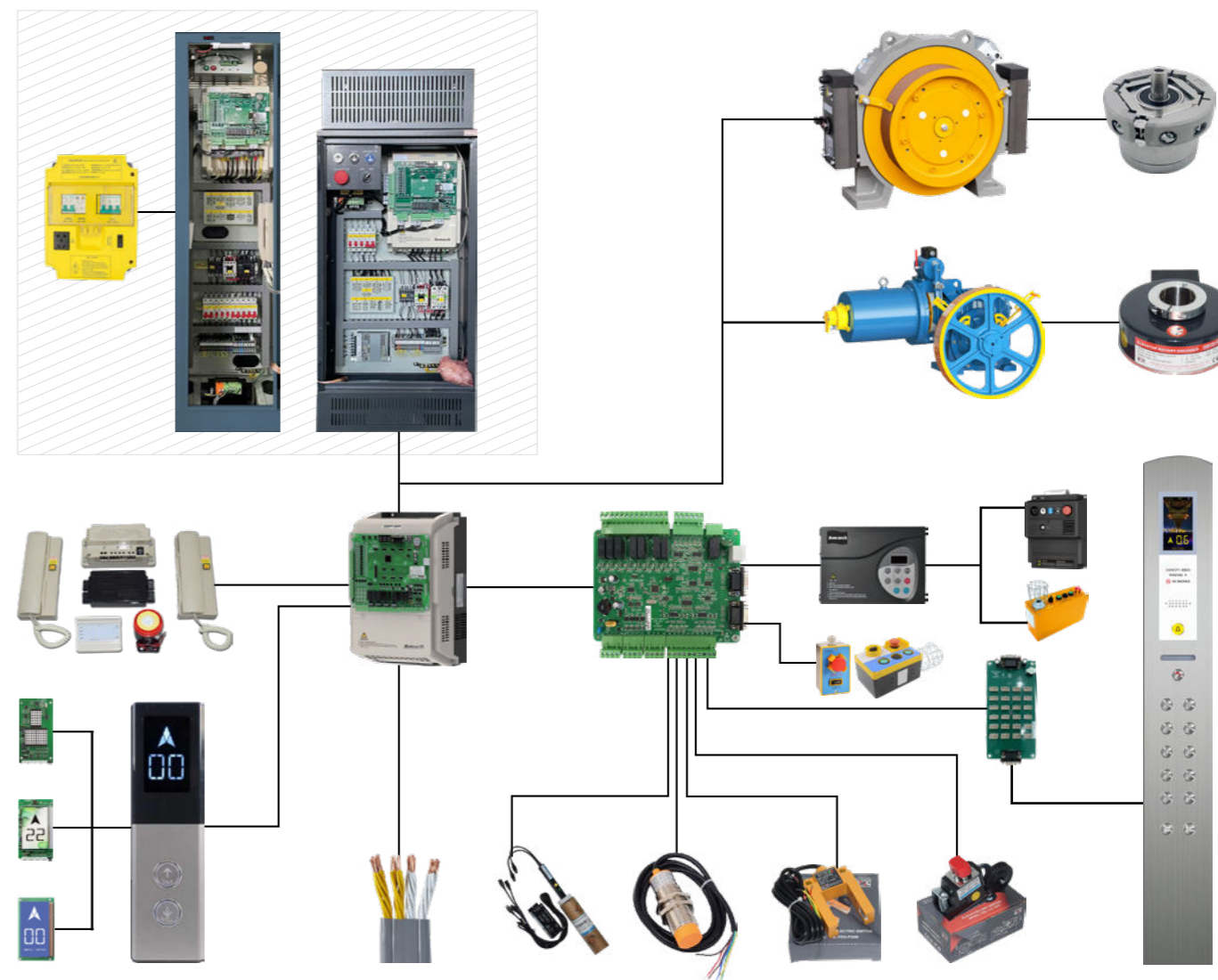

### ELEVATOR MODERNIZATION CHART 电梯现代化改造清单

ONLY CONTROL CHANGE MODERNIZATION 仅控制系统现代化改造			CONTROL & TRACTION CHANGE MODERNIZATION 控制系统 & 驱动系统现代化改造		
REQUIRE PART 需求配件	REQUIRE STATUS 配件标准	REMARKS 备注	REQUIRE PART 需求配件	REQUIRE STATUS 配件标准	REMARKS 备注
ELEVATOR CONTROL SYSTEM WITH PG CARD 电梯控制系统包括 PG 卡	ACCORDIN TO MOTOR POWER (KW) And Encoder 根据曳引机功率和编码器型号	MUST NEED TO CHANGE 必须替换	TRACTION MOTOR WITH ENCODER 曳引机及编码器	ACCORDIN TO REQUIREMENT LOAD 根据载重	MUST NEED TO CHANGE 必须替换
COMPLETE CABLE SET & POWER BOX 完整电缆线套组 & 配电箱	ACCORDING TO FLOOR & TRAVELING HEIGHT 根据楼层及行程高度	MUST NEED TO CHANGE 必须替换	MOTOR BASE 机架	DEPEND ON MOTOR MODEL & TYPE 根据曳引机型号和种类	MUST NEED TO CHANGE 必须替换
COP LOP SET 操纵盘外呼套组	ACCORDIN TO FLOOR 根据楼层	MUST NEED TO CHANGE 必须替换	STEEL ROPE SET INCLUDING FASTENING 钢丝绳包括绳头组合	ACCORDING TO FLOOR & TRAVELING HEIGHT 根据楼层及行程高度	MUST NEED TO CHANGE 必须替换
DOOR INVERTER 门机控制器	One Set for One Elevator 每部电梯需要一套	CHANGE IS BETTER 替换是最佳选择	SPEED GOVERNOR SET WITH SAFETY GEAR SET 限速器套组及安全钳套组	One Set for One Elevator 每部电梯需要一套	CHANGE IS BETTER 替换是最佳选择
CAR TOP SET INCLUDING PIT SWITCH 轿顶配件套组包括底坑开关	One Set for One Elevator 每部电梯需要一套	MUST NEED TO CHANGE 必须替换	AND ALL CONTROL CHANGE MODERNIZATION REQUIRE PARTS NEED TO ADD WITH TRACTION CHANGE PARTS 所有控制系统现代化改造项目所需配件需要增加驱动系统现代化改造配件		
DOOR SENSOR & OVERLOAD SENSOR 光幕 & 称重装置	One Set for One Elevator 每部电梯需要一套	CHANGE IS BETTER 替换是最佳选择			
LIMIT SWITCH & LABELING SWITCH, RELATED BRACKET 限位开关 & 感应开关, 相关支架	One Set for One Elevator 每部电梯需要一套	CHANGE IS BETTER 替换是最佳选择			
INTERCOM SET & FAN 对讲系统 & 风机	One Set for One Elevator 每部电梯需要一套	CHANGE IS BETTER 替换是最佳选择			



### ELEVATOR LOCK SWITCH SERIES 电梯基站锁系列



**GNLLS-1**  
• INSTALL SIZE 开孔 : 28MM



**GNLLS-2**  
• INSTALL SIZE 开孔 : 28MM



**GNLLS-3**  
• INSTALL SIZE 开孔 : 30MM



**GNLLS-4**  
• INSTALL SIZE 开孔 : 26\*26MM



**GNLLS-5**  
• INSTALL SIZE 开孔 : 28MM



**GNLLS-6**  
• INSTALL SIZE 开孔 : 30MM



**GNLLS-7**  
• INSTALL SIZE 开孔 : 19MM



**GNLLS-8**  
• INSTALL SIZE 开孔 : 16MM



**GNLLS-9**  
• INSTALL SIZE 开孔 : 30\*30MM



**GNLLS-10**  
• INSTALL SIZE 开孔 : 37\*37MM



**GNLLS-11**  
• INSTALL SIZE 开孔 : 27MM



**GNLLS-12**  
• INSTALL SIZE 开孔 : 12MM



**GNLLS-13**  
• INSTALL SIZE 开孔 : 19MM



**GNLLS-14**  
• INSTALL SIZE 开孔 : 12MM



**GNLLS-15**  
• INSTALL SIZE 开孔 : 19MM



**GNLLS-16**  
• INSTALL SIZE 开孔 : 19MM

### ELEVATOR COP LOCK SERIES 电梯操纵盘锁系列



**GNLCL-1**  
• INSTALL SIZE 开孔 : 12MM



**GNLCL-2**  
• INSTALL SIZE 开孔 : 19MM



**GNLCL-3**  
• INSTALL SIZE 开孔 : 12MM



**GNLCL-4**  
• INSTALL SIZE 开孔 : 16MM



**GNLCL-5**  
• INSTALL SIZE 开孔 : 18MM



**GNLCL-6**  
• INSTALL SIZE 开孔 : 18MM



**GNLCL-7**  
• INSTALL SIZE 开孔 : 19MM



**GNLCL-8**  
• INSTALL SIZE 开孔 : 26\*26MM

### ELEVATOR TRIANGLE LOCKS SERIES 电梯三角锁系列



**GNLTL-1**  
• INSTALL SIZE 开孔 : 19.5MM



**GNLTL-2**  
• INSTALL SIZE 开孔 : 18MM



**GNLTL-3**  
• INSTALL SIZE 开孔 : 20MM



**GNLTL-4**  
• INSTALL SIZE 开孔 : 22MM



**GNLTL-5**  
• INSTALL SIZE 开孔 : 22.5MM



**GNLTL-6**  
• INSTALL SIZE 开孔 : 22.5MM



**GNLTL-7**  
• INSTALL SIZE 开孔 : 22.5MM



**GNLTL-8**  
• INSTALL SIZE 开孔 : 25MM



**GNLTL-9**  
• INSTALL SIZE 开孔 : 22.5MM



**GNLTL-10**  
• INSTALL SIZE 开孔 : 22.5MM



**GNLTL-11**  
• INSTALL SIZE 开孔 : 22.5MM



**GNLTL-12**  
• INSTALL SIZE 开孔 : 28MM



**GNLTL-13**  
• INSTALL SIZE 开孔 : 18MM



**GNLTL-14**  
• INSTALL SIZE 开孔 : 22MM



**GNLTL-15**  
• INSTALL SIZE 开孔 : 19MM



**GNLTL-16**  
• INSTALL SIZE 开孔 : 62\*23.5MM

### ELEVATOR KEYS SERIES 电梯钥匙系列



**GNLEK-1**  
• INSTALL SIZE 开孔 : 28MM



**GNLEK-2**  
• INSTALL SIZE 开孔 : 28MM



**GNLEK-3**  
• INSTALL SIZE 开孔 : 30MM



**GNLEK-4**  
• INSTALL SIZE 开孔 : 26\*26MM



**GNLEK-5**  
• INSTALL SIZE 开孔 : 28MM



**GNLEK-6**  
• INSTALL SIZE 开孔 : 28MM



**GNLEK-7**  
• INSTALL SIZE 开孔 : 30MM



**GNLEK-8**  
• INSTALL SIZE 开孔 : 26\*26MM

ELEVATOR AVR 电梯三相高精度全自动交流稳压器



产品名称 PRODUCT NAME	三相高精度全自动交流 稳压器 THREE PHASE HIGH PRECISION AC AVR
型号规格 MODEL SPECIFICATION	GNL-15KVA
输出电流 OUTPUT CURRENT	22A
输入电压 INPUT VOLTAGE	260~450V
输出电压 OUTPUT VOLTAGE	380V
稳压精度 VOLTAGE STABILIZATION ACCURACY	220V±3%
频率 FREQUENCY	50Hz/60Hz
过压保护 OVERVOLTAGE PROTECTION	426V±4V
环境温度 AMBIENT TEMPERATURE	-10°C ~+40°C
温升 TEMPERATURE RISE	<60°C
负载功率因数 LOAD POWER FACTOR	0.8
抗电强度 ELECTRICAL STRENGTH	2000V/min
绝缘电阻 INSULATION RESISTANCE	>2MQ
防护等级 LEVEL OF PROTECTION	IP20
海拔高度 ALTITUDE ABOVE SEA LEVEL	≤ 1500m

AVR FROM 3KVA TO 150KVA AVAILABLE  
AVR 从 3KVA 到 150KVA 适用

ELEVATOR ARD 电梯停电应急装置

Model	Inverter powerx	Specifications	Number	Weight(kg)	LxWxH(mm)
GNL-ARD-3P5.5E	5.5KW	12V/7AH	3	21	402X305X160
GNL-ARD-3P7.5E	7.5KW	12V/9AH	3	21	402X305X160
GNL-ARD-3P11E	11KW	12V/7AH	4	23	402X305X160
GNL-ARD-3P15E	15KW	12V/9AH	4	26	402X305X160
GNL-ARD-3P18.5E	18.5KW	12V/9AH	4	26	402X305X160
GNL-ARD-3P22E	22KW	12V/7AH	6	45	538X400X160
GNL-ARD-3P30E	30KW	12V/9AH	6	47	538X400X160
GNL-ARD-3P55E	55KW	12V/12AH	6	57	538X400X160

MAINS INPUT	VOLTAGE	THREE PHASE AC380V ±15%
	FREQUENCY	50Hz/60Hz
	INVERTED OUTPUT VOLTAGE	THREE PHASE AC380V 10%
INVERTER OUTPUT	EFFICIENCY	≥0.85
	OUTPUT FREQUENCY	50HZ/60HZ(RATED VALUE 50HZ)
	WAVEFORM	SINE WAVE
BATTERY	TYPE	VALVE-CONTROLLED SEALED LEAD-ACID BATTERY
	RESCUE TIME	3-15 MIN(ADJUSTABLE)
	CHARGING TIME	≥6 HOURS
	AMBIENT TEMPERATURE	0°C-45°C
ENVIRONMENT	RELATIVE HUMIDITY	<90% (NO DEW)
	NOISE	≤45 DB
	ALTITUDE	≤2000M

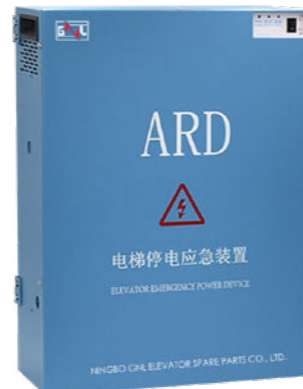

ELEVATOR CABIN & DOOR 电梯轿厢和门

